



PSEN 1.1a/b-22

PILZ

THE SPIRIT OF SAFETY

► PSEN sensor technology

This document is a translation of the original document.

All rights to this documentation are reserved by Pilz GmbH & Co. KG. Copies may be made for internal purposes. Suggestions and comments for improving this documentation will be gratefully received.

Source code from third-party manufacturers or open source software has been used for some components. The relevant licence information is available on the Internet on the Pilz homepage.

Pilz®, PIT®, PMI®, PNOZ®, Primo®, PSEN®, PSS®, PVIS®, SafetyBUS p®, SafetyEYE®, SafetyNET p®, the spirit of safety® are registered and protected trademarks of Pilz GmbH & Co. KG in some countries.



SD means Secure Digital

Introduction	4
Validity of documentation	4
Using the documentation	4
Definition of symbols	4
Safety	5
Intended use	5
Safety regulations	6
Safety assessment	6
Use of qualified personnel	6
Warranty and liability	6
Disposal	6
For your safety	7
Unit features	7
Function description	7
Block diagram	8
Operating distances	8
Lateral and vertical offset	9
Wiring	9
Pin assignment	10
Requirements and connection to evaluation devices	10
Installation	13
Adjustment	14
Periodic test	14
Dimensions in mm	15
Technical details	15
Safety characteristic data	17
Order reference	17
System	17
Accessories	17
EC declaration of conformity	18

Introduction

Validity of documentation

This documentation is valid for the product PSEN 1.1a/b-22. It is valid until new documentation is published.

This operating manual explains the function and operation, describes the installation and provides guidelines on how to connect the product.

Using the documentation

This document is intended for instruction. Only install and commission the product if you have read and understood this document. The document should be retained for future reference.

Definition of symbols

Information that is particularly important is identified as follows:



DANGER!

This warning must be heeded! It warns of a hazardous situation that poses an immediate threat of serious injury and death and indicates preventive measures that can be taken.



WARNING!

This warning must be heeded! It warns of a hazardous situation that could lead to serious injury and death and indicates preventive measures that can be taken.



CAUTION!

This refers to a hazard that can lead to a less serious or minor injury plus material damage, and also provides information on preventive measures that can be taken.



NOTICE

This describes a situation in which the product or devices could be damaged and also provides information on preventive measures that can be taken. It also highlights areas within the text that are of particular importance.

**INFORMATION**

This gives advice on applications and provides information on special features.

Safety

Intended use



The safety function of the safety switch is:

- ▶ Safe detection of the magnetic actuator within the response range

The safety switch meets the requirements in accordance with:

- ▶ EN 60947-5-3: PDDDB only in connection
 - with the actuator PSEN 1.1-20,
 - the interface PSEN ix1 and
 - the suitable evaluation devices (see [Requirements and connection to evaluation devices](#)  10).

The safety switch is designed for applications in series connections and it must only be operated with the following components:

- ▶ Actuator PSEN 1.1-20,
- ▶ interface PSEN ix1 (see [Order reference](#)  18) and
- ▶ a suitable evaluation device (see [Requirements and connection to evaluation devices](#)  10).

The following is deemed improper use in particular:

- ▶ Any component, technical or electrical modification to the product
- ▶ Use of the product outside the areas described in this manual
- ▶ Use of the product outside the technical details (see [Technical details](#)  15).

**NOTICE****EMC-compliant electrical installation**

The product is designed for use in an industrial environment. The product may cause interference if installed in other environments. If installed in other environments, measures should be taken to comply with the applicable standards and directives for the respective installation site with regard to interference.

Safety regulations

Safety assessment

Before using a unit it is necessary to perform a safety assessment in accordance with the Machinery Directive.

Functional safety is guaranteed for the product as a single component. However, this does not guarantee the functional safety of the overall plant/machine. In order to achieve the required safety level for the overall plant/machine, define the safety requirements for the plant/machine and then define how these must be implemented from a technical and organisational standpoint.

Use of qualified personnel

The products may only be assembled, installed, programmed, commissioned, operated, maintained and decommissioned by competent persons.

A competent person is a qualified and knowledgeable person who, because of their training, experience and current professional activity, has the specialist knowledge required. To be able to inspect, assess and operate devices, systems and machines, the person has to be informed of the state of the art and the applicable national, European and international laws, directives and standards.

It is the company's responsibility only to employ personnel who

- ▶ Are familiar with the basic regulations concerning health and safety / accident prevention,
- ▶ Have read and understood the information provided in this description under "Safety"
- ▶ Have a good knowledge of the generic and specialist standards applicable to the specific application.

Warranty and liability

All claims to warranty and liability will be rendered invalid if

- ▶ The product was used contrary to the purpose for which it is intended
- ▶ Damage can be attributed to not having followed the guidelines in the manual
- ▶ Operating personnel are not suitably qualified
- ▶ Any type of modification has been made (e.g. exchanging components on the PCB boards, soldering work etc.).

Disposal

- ▶ In safety-related applications, please comply with the mission time T_M in the safety-related characteristic data.
- ▶ When decommissioning, please comply with local regulations regarding the disposal of electronic devices (e.g. Electrical and Electronic Equipment Act).

For your safety



WARNING!

Loss of safety function due to manipulation of the interlocking device

Manipulation of the interlocking device may lead to serious injury and death.

- You should prevent any possibility of the interlocking device being manipulated through the use of a spare actuator.
- Keep the substitute actuator in a safe place and protect it from unauthorised access.
- If spare actuators are used, these must be installed as described in [Installation](#) [ 13].
- If the original actuators are replaced with substitute actuators, the original actuators must be destroyed before disposal.

Unit features



- ▶ The actuator PSEN 1.1-20 belongs to the safety switch.
- ▶ Coded actuator
- ▶ Safety switch with cable (5 m/ 10 m)
- ▶ 2 safety contacts (reed contacts - N/O)
- ▶ Design: Square
- ▶ Operation Magnetic
- ▶ Switching voltage 24 VDC
- ▶ Series connection via PSEN ix1 interface
- ▶ ECOLAB tested

Function description

If the actuator is within the response range (safety gate closed), the safety contacts of the safety switch are closed.

The safety switch is designed for applications in series connections.

Operate the PSEN 1.1a/b-22 in conjunction with the following components:

- ▶ Actuator PSEN 1.1-20 (see [Order reference](#) [ 17]),
- ▶ interface PSEN ix1 (see [Order reference](#) [ 18]) and
- ▶ a connected evaluation device (see [Requirements and connection to evaluation devices](#) [ 10]).

Block diagram

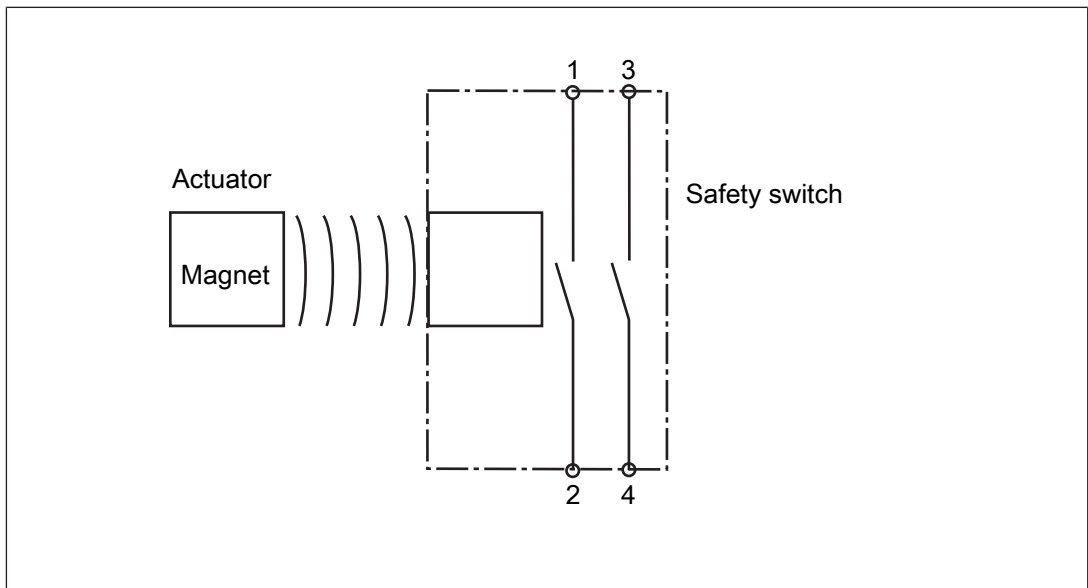

Operating distances

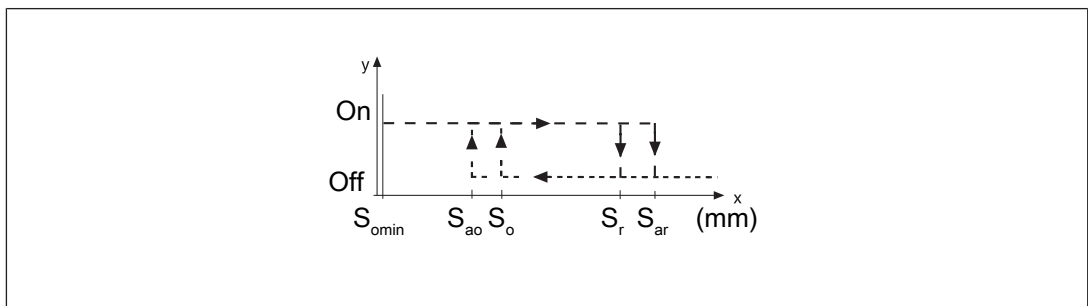

Legend

- S_{ao} Assured operating distance
- S_{omin} Min. operating distance
- S_{ar} Assured release distance

The offset-independent values for the switching distances are included in the [Technical details](#) [ 15].

Lateral and vertical offset

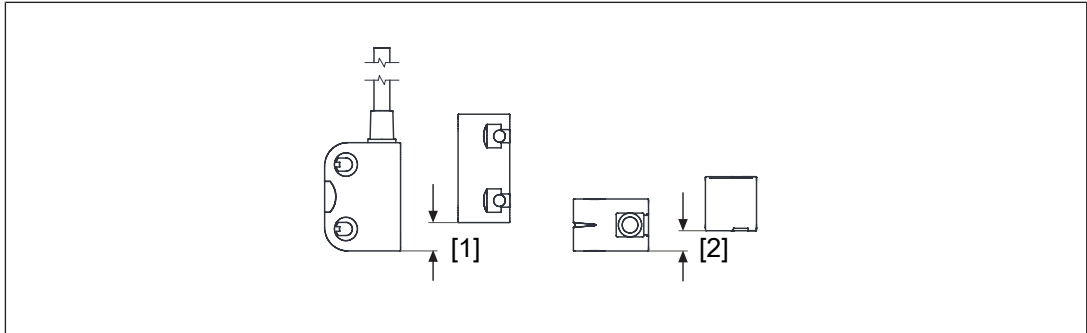

Legend

- [1] Lateral offset
- [2] Vertical offset

Actuator PSEN 1.1-20

The stated values are valid at a temperature of 20 °C.

Assured operating distance S_{ao} in mm						
Vertical offset	Lateral offset					
		1.0	1.5	2.0	2.5	3.0
1		7.5	7.5	7.5	7.0	7.0
2		7.5	7.5	7.0	7.0	7.0
3		7.0	7.0	7.0	6.5	6.5
4		6.5	6.5	6.5	6.5	6.5
5		6.0	6.0	6.0	5.5	5.5

Wiring

- ▶ Information given in the [Technical details \[15\]](#) must be followed.
- ▶ Calculation of the max. cable length l_{max} :

$$l_{max} = \frac{R_{lmax} - R_i}{R_l / km}$$

R_{lmax} = Max. overall cable resistance (see evaluation device's technical details)

R_i = Internal resistance sensor (see [Technical details \[15\]](#))

R_l / km = Cable resistance/km of the cable (see technical details cable)

- ▶ Ensure the wiring and EMC requirements of EN 60204-1 are met.
- ▶ In the following cases, check the function that detects shorts across contacts prior to commissioning:
 - On evaluation devices with DC supply voltage: Overall cable resistance ≥ 15 Ohms per channel
 - On evaluation devices with AC supply voltage: Overall cable resistance ≥ 25 Ohms per channel

- For details of how to perform the test for shorts across the contacts, please refer to the operating manual for the relevant evaluation device.

Pin assignment



NOTICE

The colour marking for the connection lead only applies for the cable that Pilz supplies as an accessory

The safety switch is shown in an unoperated condition.

Layout of the 4-core cable	<p>[1] <u>brown</u></p> <p>[2] <u>white</u></p> <p>[3] <u>blue</u></p> <p>[4] <u>black</u></p>
----------------------------	--

Requirements and connection to evaluation devices

For use of PSEN 1.1a/b-22 in accordance with DIN EN 60947-5-3 an evaluation device must be connected.

Connect the PSEN 1.1a/b-22

- ▶ **either** with a certified Pilz evaluation device
- ▶ **or** with an evaluation device with defined properties

Certified Pilz evaluation devices are, for example:

- ▶ PNOZelog for safety gate monitoring
 - PNOZ e1p, PNOZ e1.1p, PNOZ e1vp
 - PNOZ e5.11p
 - PNOZ e6vp, PNOZ e6.1p
- ▶ PNOZpower for safety gate monitoring
 - PNOZ p1p, PNOZ p1vp
- ▶ PNOZsigma for safety gate monitoring:
 - PNOZ s3
 - PNOZ s4
 - PNOZ s5
- ▶ PNOZ X for safety gate monitoring
 - PNOZ X2, PNOZ X2.5P, PNOZ X2.7P, PNOZ X2.8P, PNOZ X2.9P, PNOZ X2C,
 - PNOZ X3, PNOZ X3.1, PNOZ X3P, PNOZ X3.10P
 - PNOZ X4
 - PNOZ X5, PNOZ X5J
 - PNOZ Ex

- ▶ PNOZmulti for safety gate monitoring
Configure the switch in the PNOZmulti Configurator with switch type 3.
- ▶ PSS for safety gate monitoring with standard function block SB064, SB066 or FS_Safety Gate
- ▶ PSSuniversal PLC for safety gate monitoring with function block FS_SafetyGate

The correct connection to the respective evaluation device is described in the operating manual for the evaluation device. Make sure that the connection is made in accordance with the specifications in the operating manual for the selected evaluation device.

Defined properties of evaluation devices:

- ▶ 2-channel with feasibility monitoring
- ▶ Open circuit monitoring of the safety switch is performed
- ▶ The inputs and outputs of the evaluation device must fulfil the requirements of IEC 61131
- ▶ Technical data of the evaluation device must fulfil the requirements in the [Technical details \[15\]](#) of PSEN 1.1a/b-22
 - Always comply with the max. switching current safety contacts of PSEN 1.1a/b-22.
- ▶ Outputs at the evaluation device must only be switched on again when both reed contacts at the safety switch have been opened and closed (partial operation lock)



INFORMATION

Risk time in accordance with DIN EN 60947-5-3

The risk time is made up of the reaction time of the sensor (see [Technical details \[15\]](#)) and the processing and delay times of the evaluation device (s. operating manual for the relevant evaluation device).

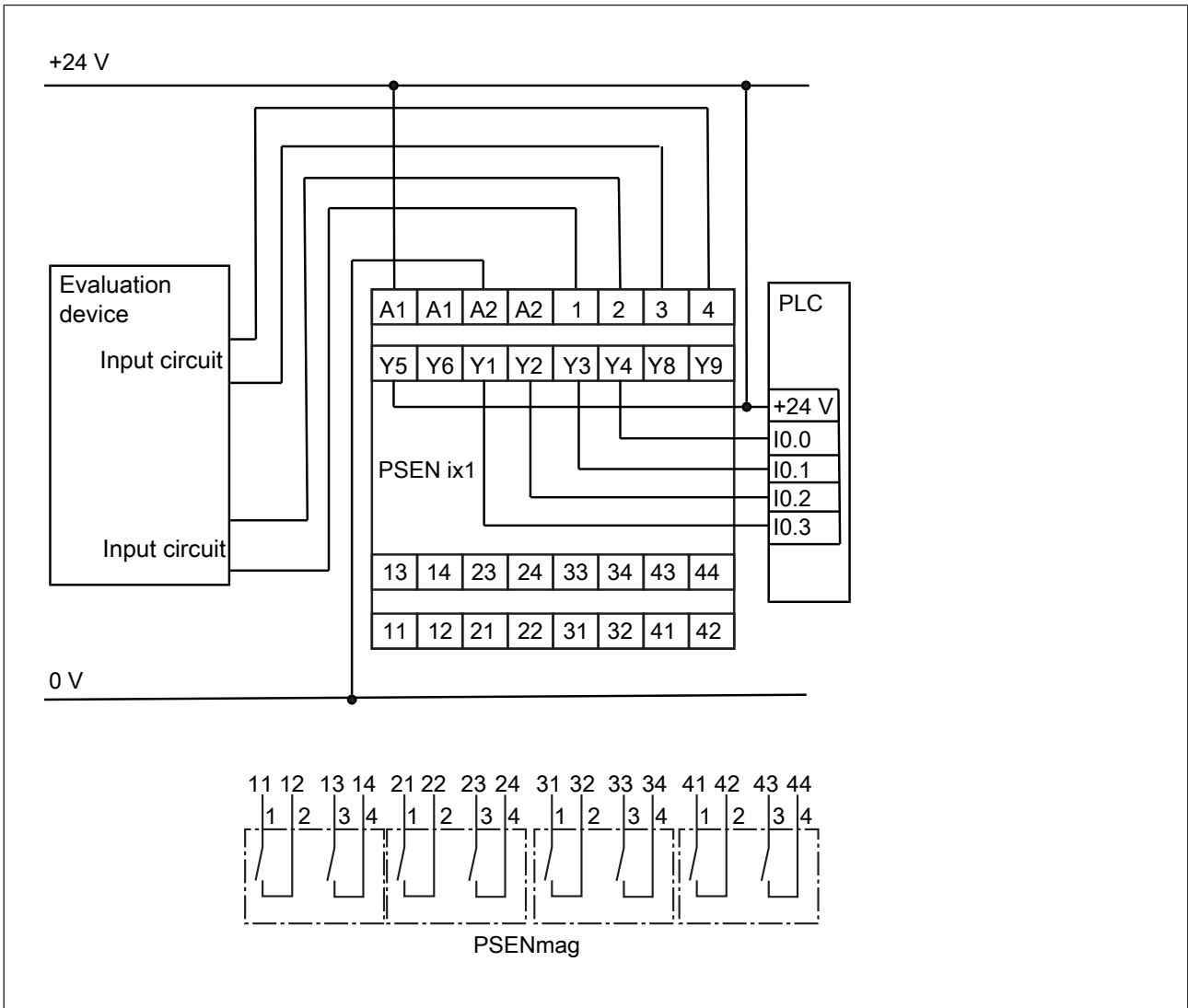
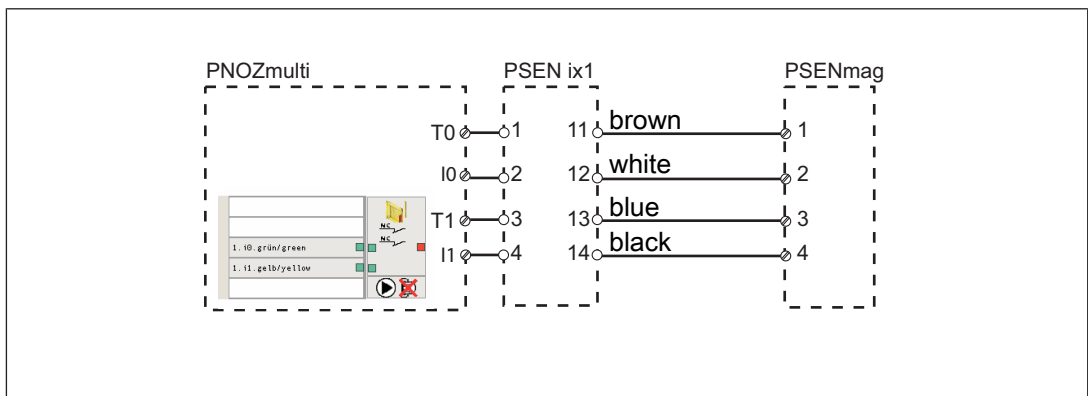

Fig.: Dual-channel connection of four PSENmag to the input circuits of an evaluation device

Examples for connection to Pilz evaluation devices:



Legend

- I0 Input OSSD
- I1 Input OSSD
- T1, T2 Test pulse outputs

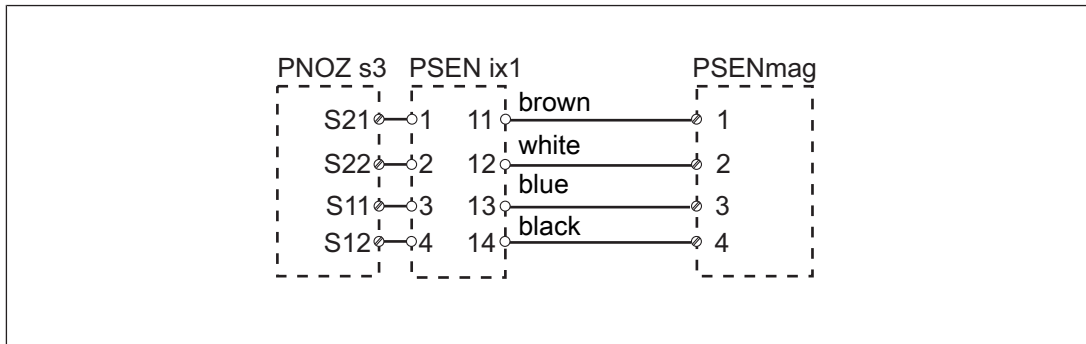

Installation



CAUTION!

Potential loss of safety function due to changed device properties

The unit's properties may be affected if installed in an environment containing electrically or magnetically conductive material.

- Please check the operating distances and the assured release distance.



CAUTION!

Possible loss of the safety function by changing the release distance S_{ar} with non-flush installation

Installing the safety switch non-flush within electrically or magnetically conductive material, the value for the assured release distance S_{ar} can change.

- Check the assured release distance S_{ar} .

- ▶ Safety switches and actuators must be positioned so that they are secured against a change of position.
- ▶ The safety switch and actuator should only be secured using screws and nuts made of non-magnetic material (e.g. brass or stainless steel).
- ▶ Avoid the risk of damages from foreseeable external influences by attaching the safety switch and actuator. If necessary, safety switch and actuator have to be protected.



INFORMATION

The actuator should be protected from unauthorised removal and from contamination.

- ▶ Prevent self-loosening of the fastening elements of safety switch and actuator.
- ▶ The fastening of safety switch and actuator has to be sufficiently stable to ensure the proper operation of the safety switch and the actuator.

- ▶ The distance between two safety switches must be maintained (see [Technical details \[15\]](#)).
- ▶ Safety switches and actuators
 - Should be kept away from iron swarf
 - Should not be exposed to strong magnetic fields
 - Should be used for fixed wiring only
- ▶ Prevent the safety switch and actuator being exposed to heavy shock or vibration
- ▶ Make sure that the safety switch and actuator cannot be used as an end stop.
- ▶ Circumvention of the safety switch in a reasonably foreseeable manner must be prevented.
- ▶ Please note the installation measures in accordance with EN ISO 14119 for a proximity switch design 4 and with level of coding Low
- ▶ Alignment errors of the guard must not adversely affect the safety function of the guard.
- ▶ The assured operating distance S_{ao} and the assured release distance S_{ar} must be tested under real conditions.
- ▶ Install safety switch and actuator
 - facing each other in parallel
 - so that the faces with the product names are opposite each other.
- ▶ If possible, do not install the safety switch and actuator on to ferromagnetic material. Changes to the operating distances are to be expected. In this case, use the spacer (see [Order reference \[17\]](#)).
- ▶ Safety switches and actuators should only be secured using M4 screws with a flat head (e.g. M4 cheese-head or pan head screws). Use screws made of non-magnetic material (e.g. brass).

Adjustment

- ▶ The safety switch may only be used with the corresponding actuator PSEN 1.1-20.
- ▶ Always test the function with the PSEN ix1 interface and connected evaluation device.
- ▶ The stated operating distances (see [Technical details \[15\]](#)) only apply when the safety switch and actuator are installed according to the specifications [Installation \[13\]](#). Operating distances may deviate if other arrangements are used. Note the maximum permitted lateral and vertical offset (see [Operating distances and Lateral and vertical offset \[8\]](#)).

Periodic test

- ▶ Carry out a monthly function test on the safety switch and actuator.
- ▶ Always test the function with a connected evaluation device.
- ▶ The safety function may only be checked by qualified personnel.

Dimensions in mm

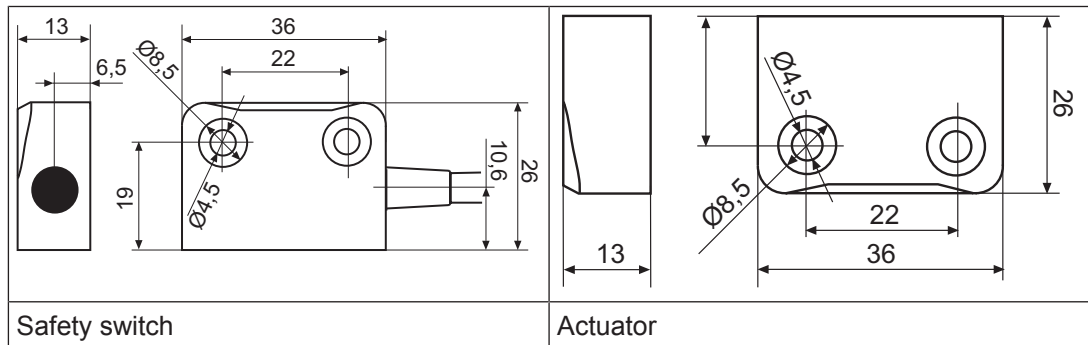

Technical details

General	504228	504229
Approvals	CE, EAC (Eurasian), ECOLAB, TÜV, cULus Listed	CE, EAC (Eurasian), ECOLAB, TÜV, cULus Listed
Sensor's mode of operation	Magnetic	Magnetic
Coding level in accordance with EN ISO 14119	Low	Low
Design in accordance with EN ISO 14119	4	4
Classification in accordance with EN 60947-5-3	PDDB	PDDB
Electrical data	504228	504229
Supply voltage		
Voltage	24 V	24 V
Kind	DC	DC
Voltage tolerance	-20 %/+20 %	-20 %/+20 %
Max. switching frequency	1 Hz	1 Hz
Lowest operating current (I _m)	1 mA	1 mA
Switching voltage	24 V	24 V
Internal resistance	0 Ohm	0 Ohm
Max. switching current, safety contacts	0,5 A	0,5 A
Max. breaking capacity, safety contacts	10 W	10 W
Times	504228	504229
Reaction time (actuator removed)	2 ms	2 ms
Environmental data	504228	504229
Ambient temperature		
Temperature range	-10 - 70 °C	-10 - 70 °C
Climatic suitability		
In accordance with the standard	IEC 60068-2-30	IEC 60068-2-30
Humidity	93 % r. h. at 40 °C	93 % r. h. at 40 °C
Max. operating height above sea level	2000 m	2000 m

Environmental data	504228	504229
EMC	EN 60947-5-3	EN 60947-5-3
Vibration		
In accordance with the standard	EN 60947-5-2	EN 60947-5-2
Frequency	10 - 55 Hz	10 - 55 Hz
Amplitude	1 mm	1 mm
Shock stress		
Acceleration	30g	30g
Duration	11 ms	11 ms
Airgap creepage		
Pollution degree	3	3
Rated insulation voltage	250 V	250 V
Rated impulse withstand voltage	4 kV	4 kV
Protection type		
Housing	IP69K	IP69K
Mechanical data	504228	504229
Actuator 1	PSEN 1.1-20	PSEN 1.1-20
Typ. Hysteresis	5 mm	5 mm
Operating distances		
Assured operating distance Sao	8 mm	8 mm
Min. operating distance Somin	0,5 mm	0,5 mm
Assured release distance Sar	26 mm	26 mm
Repetition accuracy switching distances	8 %	8 %
Sensor flush installation in accordance with EN 60947-5-2	Yes, follow installation guidelines	Yes, follow installation guidelines
Connection type	5 m cable	10 m cable
Cable	LiY11Y 4 x 0,25 mm²	LiY11Y 4 x 0,25 mm²
Material		
Top	PBT	PBT
Max. torque setting		
Safety switch	1 Nm	1 Nm
Actuator 1	1 Nm	1 Nm
Dimensions		
Height	36 mm	36 mm
Width	26 mm	26 mm
Depth	13 mm	13 mm
Actuator dimensions		
Height	36 mm	36 mm
Width	26 mm	26 mm
Depth	13 mm	13 mm
Weight of safety switch	150 g	320 g
Weight of actuator	17 g	17 g
Weight	192 g	357 g

Where standards are undated, the 2015-09 latest editions shall apply.

Safety characteristic data**NOTICE**

You must comply with the safety-related characteristic data in order to achieve the required safety level for your plant/machine.

**B10d in accordance with EN ISO 13849-1: 2015
and EN 62061**

500.000

**TM [year] in accordance with EN ISO
13849-1:2015**

20

Order reference**System**

Product type	Features	Connection type	Order no.
PSEN 1.1a-22/PSEN 1.1-20 /8mm/5m/ix1/1un	Magnetic safety switch, actuator cube, with assured operating distance 8 mm	Cable, 5 m	504 228
PSEN 1.1b-22/PSEN 1.1-20 /8mm/10m/ix1/1u	Magnetic safety switch, actuator cube, with assured operating distance 8 mm	Cable, 10 m	504 229
PSEN 1.1a-22 /8mm/5m/ix1/1switch	Magnetic safety switch	Cable, 5 m	524128
PSEN 1.1b-22/8mm /10m/ix1/1switch	Magnetic safety switch	Cable, 10 m	524127
PSEN 1.1-20 / 1 actuator	Actuator cube, with assured operating distance 8 mm		514 120

Accessories**Installation materials**

Product type	Features	Order no.
PSEN Winkel / bracket	Mounting bracket	532 110
PSEN spacer	Spacer	534 310
PSEN reverse spacer	Spacer	534 320
PSEN screw M4x16 10pcs	Screws made of high-grade steel with one-way slot	540 310

Connector

Product type	Features	Order no.
PSS67 M12 connector	Connector, M12, straight, 5-pin, A-coded	380 308
PSS67 M12 connector	Socket, M12, straight, 5-pin, A-coded	380 309

Series connection

Product type	Features	Order no.
PSEN ix1 Interface for 4 PSEN 1	Interface PSEN ix1 for connecting and evaluating several safety switches PSEN ma	535 120

EC declaration of conformity

This product/these products meet the requirements of the directive 2006/42/EC for machinery of the European Parliament and of the Council. The complete EC Declaration of Conformity is available on the Internet at www.pilz.com/downloads.

Representative: Norbert Fröhlich, Pilz GmbH & Co. KG, Felix-Wankel-Str. 2, 73760 Ostfildern, Germany

► Support

Technical support is available from Pilz round the clock.

Americas

Brazil

+55 11 97569-2804

Canada

+1 888-315-PILZ (315-7459)

Mexico

+52 55 5572 1300

USA (toll-free)

+1 877-PILZUSA (745-9872)

Asia

China

+86 21 60880878-216

Japan

+81 45 471-2281

South Korea

+82 31 450 0680

Australia

+61 3 95600621

Europe

Austria

+43 1 7986263-0

Belgium, Luxembourg

+32 9 3217575

France

+33 3 88104000

Germany

+49 711 3409-444

Ireland

+353 21 4804983

Italy, Malta

+39 0362 1826711

Scandinavia

+45 74436332

Spain

+34 938497433

Switzerland

+41 62 88979-30

The Netherlands

+31 347 320477

Turkey

+90 216 5775552

United Kingdom

+44 1536 462203

You can reach our international hotline on:

+49 711 3409-444

support@pilz.com

Pilz develops environmentally-friendly products using ecological materials and energy-saving technologies. Offices and production facilities are ecologically designed, environmentally-aware and energy-saving. So Pilz offers sustainability, plus the security of using energy-efficient products and environmentally-friendly solutions.

*Energy
saving by Pilz*



Pilz GmbH & Co. KG
Felix-Wankel-Straße 2
73760 Ostfildern, Germany
Tel.: +49 711 3409-0
Fax: +49 711 3409-133
info@pilz.com
www.pilz.com

PILZ
THE SPIRIT OF SAFETY