



Visualisation; Diagnostics

Easy to Configure

Programming IEC 61131-3

Rapid Installation

PDP67 F 8DI ION

PILZ
THE SPIRIT OF SAFETY

► Decentralised periphery

This document is a translation of the original document.

All rights to this documentation are reserved by Pilz GmbH & Co. KG. Copies may be made for internal purposes. Suggestions and comments for improving this documentation will be gratefully received.

Source code from third-party manufacturers or open source software has been used for some components. The relevant licence information is available on the Internet on the Pilz homepage.

Pilz®, PIT®, PMI®, PNOZ®, Primo®, PSEN®, PSS®, PVIS®, SafetyBUS p®, SafetyEYE®, SafetyNET p®, the spirit of safety® are registered and protected trademarks of Pilz GmbH & Co. KG in some countries.



SD means Secure Digital

Section 1	Introduction	4
	1.1 Validity of documentation	4
	1.1.1 Retaining the documentation	4
	1.2 Definition of symbols	4
Section 2	Overview	6
	2.1 Unit structure	6
	2.1.1 Unit features	6
	2.2 Front view	7
	2.3 Scope of supply	7
Section 3	Safety	8
	3.1 Intended use	8
	3.2 Safety regulations	8
	3.2.1 Use of qualified personnel	8
	3.2.2 Warranty and liability	8
	3.2.3 Disposal	9
Section 4	Function description	10
	4.1 Operation	10
	4.1.1 Inputs	10
	4.1.2 Outputs	10
	4.2 Data download	10
	4.3 Diagnostics	10
Section 5	Installation	11
	5.1 General installation guidelines	11
	5.2 Dimensions	11
Section 6	Wiring	12
	6.1 General wiring guidelines	12
	6.2 Connector pin assignment	13
	6.3 Wiring examples	14
	6.3.1 Example: Single-channel, failsafe input device, without test pulse	14
	6.3.2 Example: Dual-channel input devices, without test pulses	15
	6.3.3 Example: Single-channel, failsafe input device, with test pulse	16
	6.3.4 Example: Dual-channel, failsafe input device, with test pulse	18
Section 7	Operation	19
	7.1 Messages	19
Section 8	Technical details	20
	8.1 Safety characteristic data	22
Section 9	Order reference	23
	9.1 Order reference for module	23
	9.2 Order reference for accessories	23

1 Introduction

1.1 Validity of documentation

This documentation is valid for the products PDP67 F 8DI ION, PDP67 F 8DI ION VA. It is valid until new documentation is published.

This operating manual explains the function and operation, describes the installation and provides guidelines on how to connect the product.

1.1.1 Retaining the documentation

This documentation is intended for instruction and should be retained for future reference.

1.2 Definition of symbols

Information that is particularly important is identified as follows:



DANGER!

This warning must be heeded! It warns of a hazardous situation that poses an immediate threat of serious injury and death and indicates preventive measures that can be taken.



WARNING!

This warning must be heeded! It warns of a hazardous situation that could lead to serious injury and death and indicates preventive measures that can be taken.



CAUTION!

This refers to a hazard that can lead to a less serious or minor injury plus material damage, and also provides information on preventive measures that can be taken.



NOTICE

This describes a situation in which the product or devices could be damaged and also provides information on preventive measures that can be taken. It also highlights areas within the text that are of particular importance.

**INFORMATION**

This gives advice on applications and provides information on special features.

2 Overview

2.1 Unit structure

2.1.1 Unit features

Application of the products PDP67 F 8DI ION, PDP67 F 8DI ION VA:

Decentralised input module for connection to a Pilz control system, for use in a rugged industrial environment up to protection type IP67.

The product has the following features:

- ▶ Protection type IP67
- ▶ 8 inputs for connecting 8 single-channel or 4 dual-channel sensors
- ▶ 8 outputs, which can be configured as
 - Standard outputs
 - Test pulse outputs
 - 24 V outputs
- ▶ LED for:
 - Operating status
 - Connection status
 - Fault
 - Input status at each input

2.2 Front view

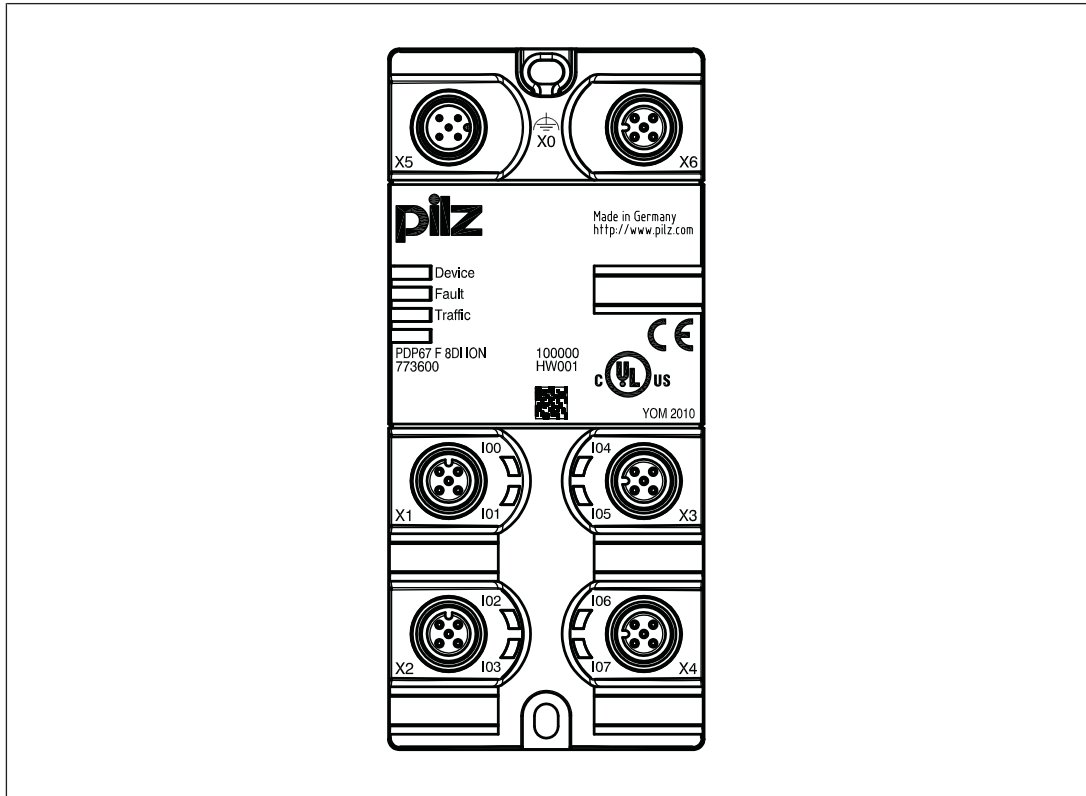

Legend:

- ▶ X1 ... X4:
Inputs and outputs
- ▶ X5:
Interface to the control system or to X6 on the upstream module
- ▶ X6:
Interface to X5 on the downstream module
- ▶ LEDs:
 - Device
 - Fault
 - Traffic
 - IO0 ... IO7

2.3 Scope of supply

- ▶ Decentralised input module PDP67 F 8DI ION/PDP67 F 8DI ION VA
- ▶ 4 blind plugs

3 Safety

3.1 Intended use

The products PDP67 F 8DI ION, PDP67 F 8DI ION VA are decentralised input modules designed for use in a rugged industrial environment up to protection type IP67.

The module can be connected to a link module PNOZ ml2p or PNOZ mml2p from the configurable control system PNOZmulti.

The following is deemed improper use in particular:

- ▶ Any component, technical or electrical modification to the product
- ▶ Use of the product outside the areas described in this manual
- ▶ Use of the product outside the technical details (see Technical details).



NOTICE

EMC-compliant electrical installation

The product is designed for use in an industrial environment. The product may cause interference if installed in other environments. If installed in other environments, measures should be taken to comply with the applicable standards and directives for the respective installation site with regard to interference.

3.2 Safety regulations

3.2.1 Use of qualified personnel

The products may only be assembled, installed, programmed, commissioned, operated, maintained and decommissioned by competent persons.

A competent person is someone who, because of their training, experience and current professional activity, has the specialist knowledge required to test, assess and operate the work equipment, devices, systems, plant and machinery in accordance with the general standards and guidelines for safety technology.

It is the company's responsibility only to employ personnel who:

- ▶ Are familiar with the basic regulations concerning health and safety / accident prevention
- ▶ Have read and understood the information provided in this description under "Safety"
- ▶ And have a good knowledge of the generic and specialist standards applicable to the specific application.

3.2.2 Warranty and liability

All claims to warranty and liability will be rendered invalid if:

- ▶ The product was used contrary to the purpose for which it is intended
- ▶ Damage can be attributed to not having followed the guidelines in the manual or
- ▶ Operating personnel are not suitably trained.

3.2.3

Disposal

- ▶ In safety-related applications, please comply with the mission time T_M in the safety-related characteristic data.
- ▶ When decommissioning, please comply with local regulations regarding the disposal of electronic devices (e.g. Electrical and Electronic Equipment Act).

4 Function description

4.1 Operation

The functions of the inputs and outputs are configured in the system software.

4.1.1 Inputs

Single and dual-channel sensors can be connected to the inputs, with or without test pulses.

Input signals must show a "High" ("1" signal) of 15 VDC (+15 ... +30 VDC) and a "Low" ("0" signal) of 0 VDC (-3 ... +5 VDC).

The input status is signalled to the control system via the bus.

Green LEDs indicate the status of the inputs.

Test pulses can be used to check the inputs for shorts across contacts and correct functionality.

4.1.2 Outputs

The outputs can be used as standard outputs, as test pulse outputs or as 24 VDC outputs.

The test pulse outputs are suitable for testing the sensor wiring. All safety-related inputs must operate in accordance with the failsafe principle (on switching off).

Two test pulses are available on each plug-in connector; these test pulses are permanently assigned to the inputs. The assignment of the test pulses to the inputs cannot be changed in the system software's configurator.

If the test pulse outputs are not being used, they can be configured as standard outputs or 24 VDC outputs in the system software's configurator.

4.2 Data download

Communication with the control system is via a safe data link. Data is exchanged cyclically.

4.3 Diagnostics

The status and error messages shown by the LEDs are saved in an error stack. The system software can read this error stack.

5 Installation

5.1 General installation guidelines

The product must be fastened to a flat mounting surface, so that there is no strain on the housing when the module is screwed down. The mounting distances will depend on which plug-in connectors are used and on the bending radius of the cables. Unused connectors should be sealed using blind plugs.

To install the system, proceed as follows:

- ▶ Fit 2 x M4 internal threads on the mounting surface.
- ▶ Use two fixing screws to attach the product to the mounting plate.
- ▶ With shielded cables, connect the functional earth to the upper fixing screw X0.

5.2 Dimensions

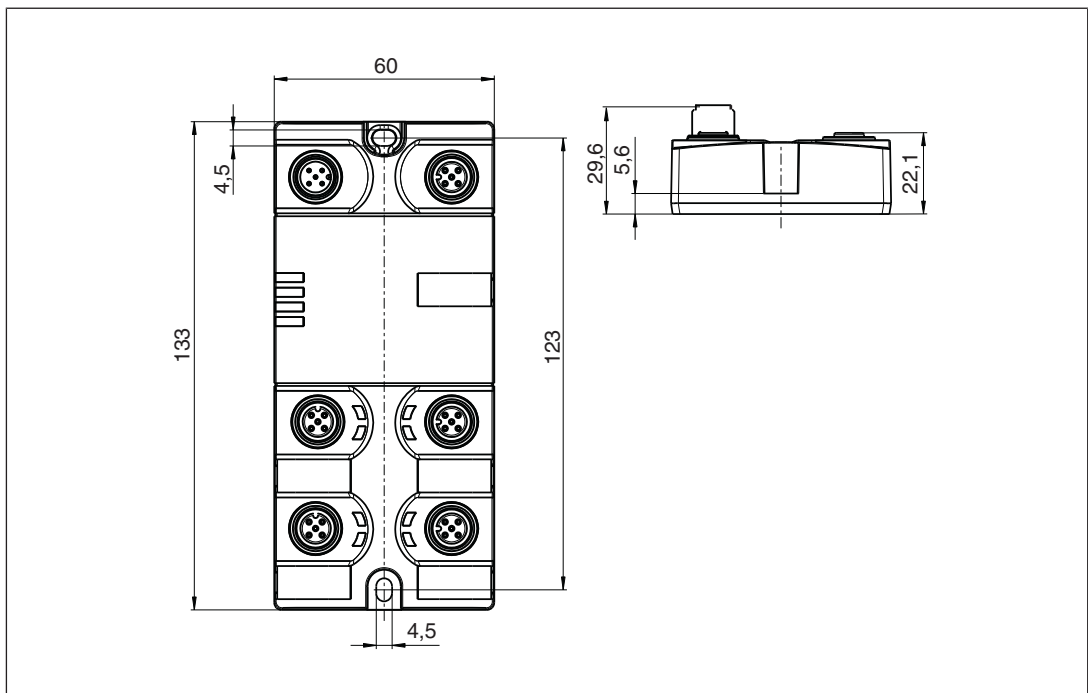

6 Wiring

6.1 General wiring guidelines

Please note:

- ▶ Information given in the "Technical details" must be followed.
- ▶ Where safety-related applications are concerned, it is essential that short circuits and open circuits are unable to cause a hazardous condition within a plant. The way in which this is done will depend on the degree of hazard from the plant section, the switching frequency of the sensors and the level of safety of the sensors and actuators.
- ▶ Please refer to the link module's operating manual for details of the maximum cable length.
- ▶ Pilz pre-assembled cable can be used to connect the inputs and outputs (see order reference).
- ▶ We recommend you use pre-assembled Pilz connectors to connect the inputs and test pulse outputs (see order reference).

**CAUTION!**

The supply voltages for an external device must be extra low voltages with safe electrical separation (PELV or SELV) in accordance with VDE 0100, Part 410.

**CAUTION!**

In order to guarantee protection type IP67, unused plug-in connectors should be sealed using the blind plugs supplied.

**CAUTION!**

Make sure that the plug-in connectors are connected to the sensors correctly. Once you have run a function test to check that the plug-in connectors are connected to the sensors correctly, the inputs should be labelled. If the inputs are connected to the sensors incorrectly, life-threatening situations may arise on the plant.

6.2 Connector pin assignment

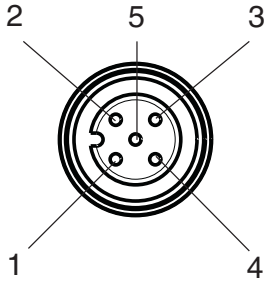
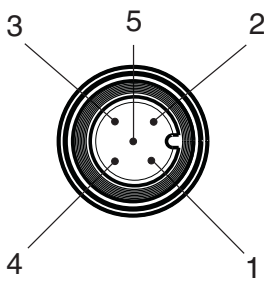
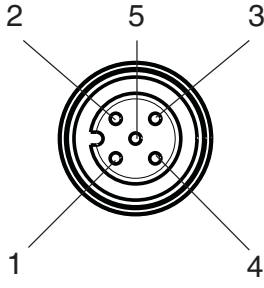
Inputs/outputs X1 to X4	Assignment	
5-pin M12 female connector A-coded	1: Test pulse x / 24 VDC / ST output. 2: Input X 3: 0 V 4: Input X + 1 5: Test pulse X + 1 / 24 VDC / ST output	
Interface to the link module: X5	Assignment	
5 pin M12 male connector A-coded	1: VCC 2: CAN- 3: GND 4: CAN+ 5: Shield	
Interface to the next decentralised module: X6	Assignment	
5-pin M12 female connector A-coded	1: VCC 2: CAN- 3: GND 4: CAN+ 5: Shield	

6.3 Wiring examples

6.3.1 Example: Single-channel, failsafe input device, without test pulse

Features:

- ▶ Depending on the application area and its respective regulations, this connection diagram is suitable for **input devices with frequent and infrequent operation** in accordance with EN ISO 13849-1 **up to PL d** and EN IEC 62061 **up to SIL CL 2**.
- ▶ The input device must be approved for failsafe applications.
- ▶ Please read the instructions provided with the input device.



WARNING!

Short circuits between the cable to the input device and the 24 V line or between cables to various input devices will not be detected. Depending on the application, serious injury or death may result.

Avoid short circuits by

- Appropriate wiring
- Wiring in accordance with the requirements of IEC 61076-2-101 and IEC 60204-1, clause 14.1.1 and 14.1.2

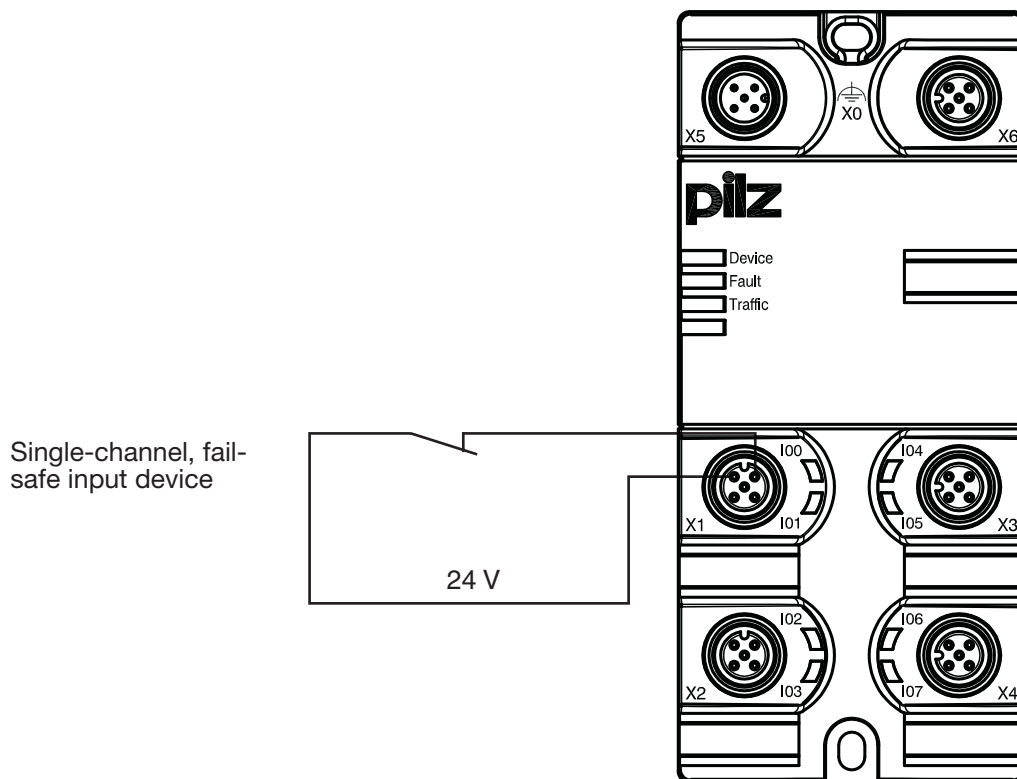

Please ensure safety regulations and EMC guidelines are met!

6.3.2 Example: Dual-channel input devices, without test pulses

Features:

- ▶ This type of connection is mainly used for signal inputs with frequent operation.
- ▶ Depending on the application area and its respective regulations, this connection diagram is suitable for **input devices with frequent operation** and diverse channels in accordance with EN ISO 13849-1 **up to PL e** and EN IEC 62061 **up to SIL CL 3**, provided the functionality of both input device channels is monitored in the user program via a **feasibility check**.
- ▶ The input device must be approved for failsafe applications.
- ▶ If you are using input devices with different (diverse) channels, adjacent inputs may be used. The user program will detect short circuits via the feasibility check.



WARNING!

Short circuits between the cable to the input device and the 24 V line or between cables to various input devices will not be detected. Depending on the application, serious injury or death may result.

Avoid short circuits by

- Appropriate wiring
- Wiring in accordance with the requirements of IEC 61076-2-101 and IEC 60204-1, clause 14.1.1 and 14.1.2

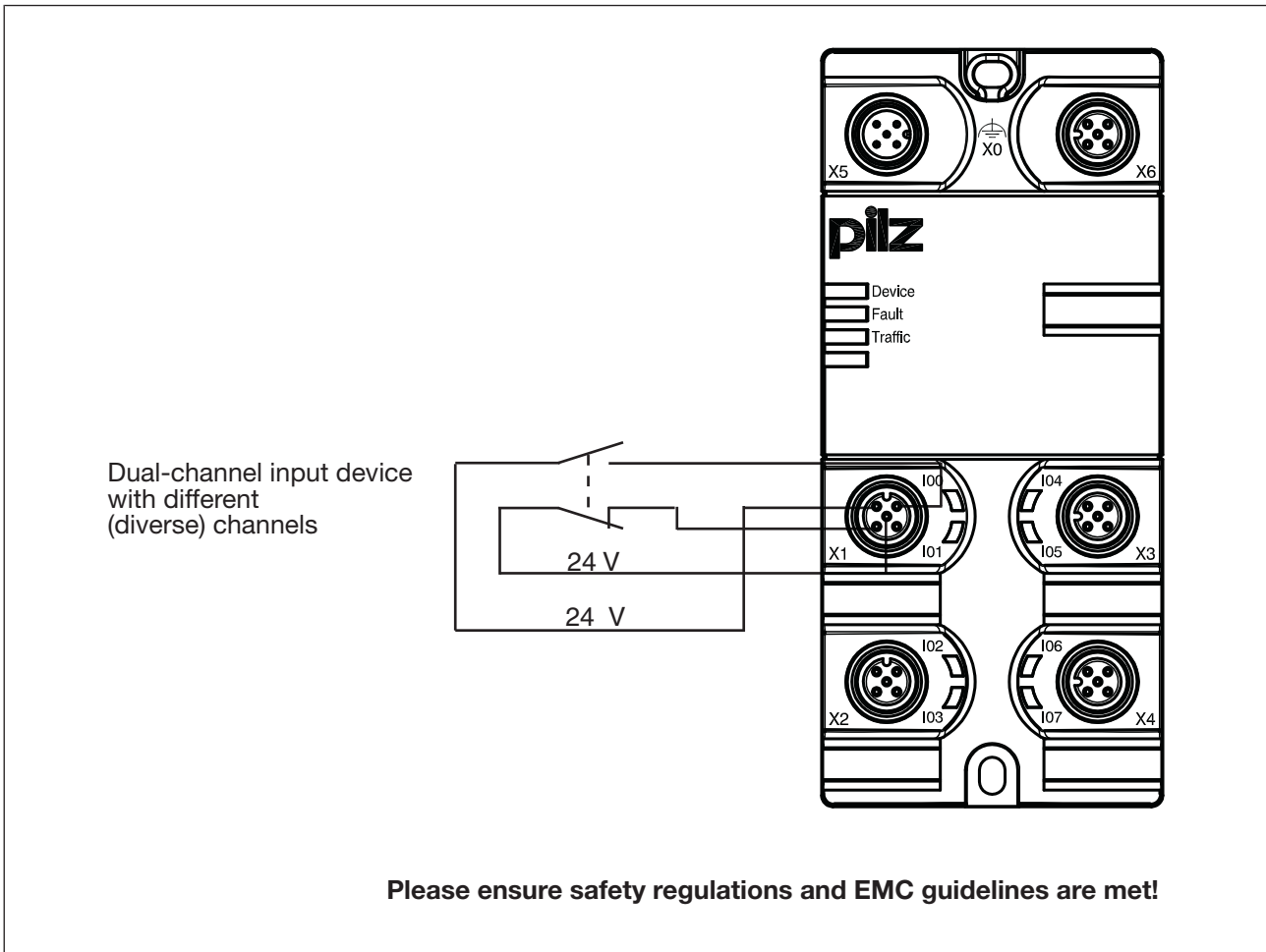

6.3.3 Example: Single-channel, failsafe input device, with test pulse

Features:

- ▶ Depending on the application area and its respective regulations, this connection diagram is suitable in accordance with EN ISO 13849-1 **up to PL d** and EN IEC 62061 **up to SIL CL 2**.
- ▶ The input device must be approved for failsafe applications.
- ▶ Test pulses can be used to check the inputs for short circuit to 24 V and correct functionality. Short circuits that short out the input device (cable from the test pulse to the input device and cable from the input device to the input) will not be detected.
- ▶ Please read the instructions provided with the input device.
- ▶ Only input devices with N/C contacts can be tested.

**CAUTION!**

Short circuits between the cable to the input device and the 24 V line or between cables to various input devices will not be detected.

Avoid short circuits by

- Appropriate wiring
- Wiring in accordance with the requirements of IEC 61076-2-101 and IEC 60204-1, clause 14.1.1 and 14.1.2

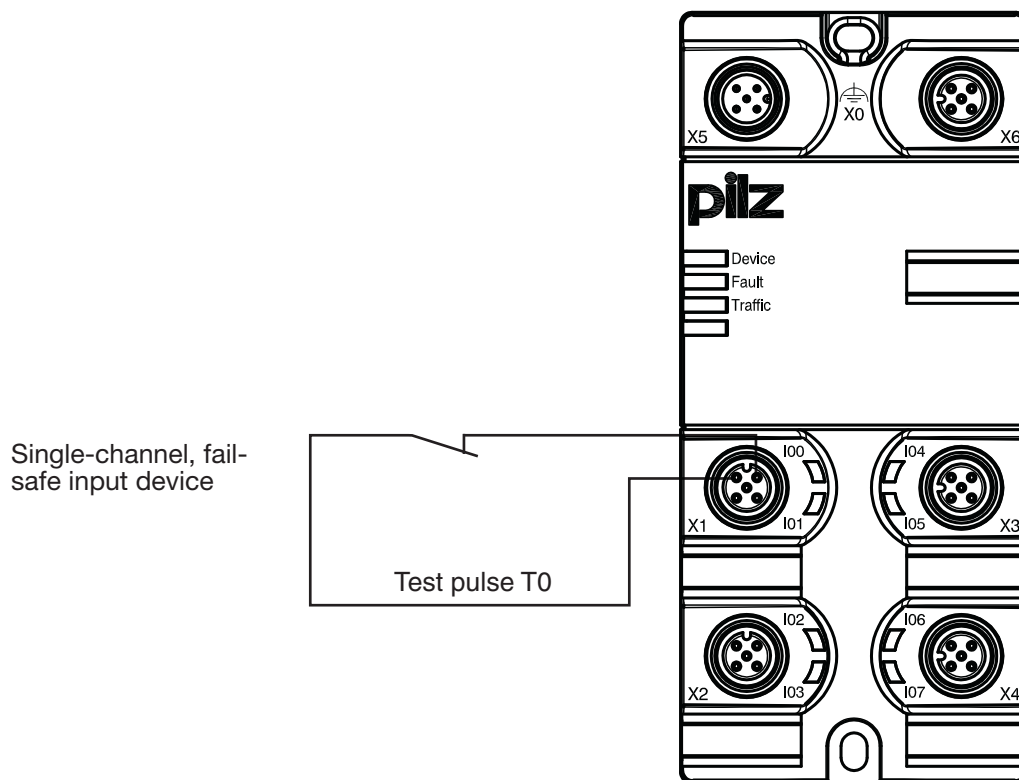

Please ensure safety regulations and EMC guidelines are met!

6.3.4 Example: Dual-channel, failsafe input device, with test pulse

Features:

- ▶ Depending on the application area and its respective regulations, this connection diagram is suitable in accordance with EN ISO 13849-1 **up to PL e** and EN IEC 62061 **up to SIL CL 3**.
- ▶ The input device must be approved for failsafe applications.
- ▶ This type of connection is mainly used for signal inputs with infrequent operation.
- ▶ As the test pulses are permanently assigned to the inputs, all short circuits will be detected, with the exception of short circuits that short out the input device (cable from the test pulse to the input device and cable from the input device to the input).

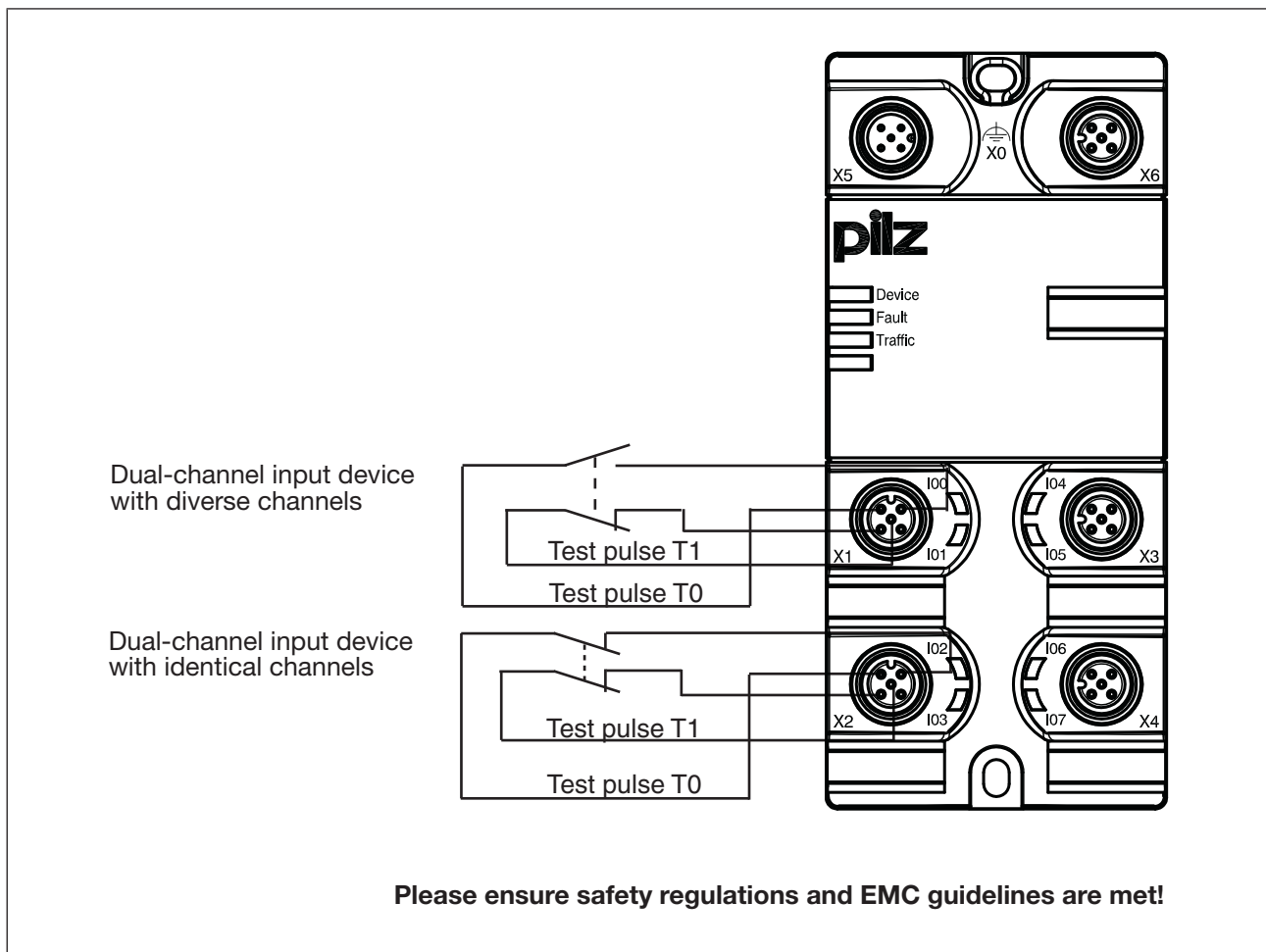















7 Operation

7.1 Messages

The module is ready for operation when the "Ready" LED on the link module is lit continuously.

Legend

-  LED on
-  LED flashes
-  LED off

LED	LED status		Meaning
Device		Green	The unit is ready for operation
		Green	The supply voltage is/was too low. Once the fault has been rectified, the LED will not stop flashing until the system has been switched off and then on again.
			The unit is not ready for operation
FAULT		Red	Internal error
			No error
Traffic		Yellow	Connection to control system established
		Yellow	Error in the connection to the control system. Flashing stops a max. of 1 min. after the fault has been rectified.
			No connection to control system established
Input LEDs		Green	1 signal is present
		Green	Link module has detected a pulse error. Once the fault has been rectified, the decentralised input module will continue to work normally after a waiting period of just a few seconds.
			0 signal is present

8 Technical details

General	773600	773614
Approvals	BG, CE, TÜV, cULus Listed	BG, CE, TÜV, cULus Listed
Application range	Standard/failsafe	Standard/failsafe
Electrical data	773600	773614
Supply voltage		
for	Supply	Supply
Voltage	24 V	24 V
Kind	DC	DC
Voltage tolerance	-30 %/+25 %	-30 %/+25 %
Current load capacity at UB	4,0 A	4,0 A
Output of external power supply (DC)	1,2 W	1,2 W
Terminal voltage when switching off inductive loads	-45 V	-45 V
Permitted loads	inductive, capacitive, resistive	inductive, capacitive, resistive
Inputs	773600	773614
Number	8	8
Signal level at "0"	-3 - +5 V DC	-3 - +5 V DC
Signal level at "1"	15 - 30 V DC	15 - 30 V DC
Input voltage in accordance with EN 61131-2 Type 1	24 V DC	24 V DC
Input current at rated voltage	3 mA	3 mA
Input current range	3,0 mA	3,0 mA
Min. threshold voltage when signal changes from "1" to "0"	7,5 V	7,5 V
Max. threshold voltage when signal changes from "0" to "1"	11,5 V	11,5 V
Max. processing time of input when signal changes from "1" to "0"	1,000 ms	1,000 ms
Max. processing time of input when signal changes from "0" to "1"	1,200 ms	1,200 ms
Min. processing time of input when signal changes from "1" to "0"	0,50 ms	0,50 ms
Min. processing time of input when signal changes from "0" to "1"	0,70 ms	0,70 ms
Potential isolation	No	No
Semiconductor outputs	773600	773614
Number of positive-switching single-pole semiconductor outputs	8	8
Function	24 VDC output, standard output, test pulse output	24 VDC output, standard output, test pulse output
Rated voltage	24 V DC	24 V DC
Typ. output current at "1" signal and rated voltage of semiconductor output	0,50 A	0,50 A
Permitted current range	0,00 - 0,60 A	0,00 - 0,60 A

Semiconductor outputs	773600	773614
Residual current at "0" signal	0,02 mA	0,02 mA
Max. internal voltage drop	200 mV	200 mV
Potential isolation	No	No
Short circuit-proof	yes	yes
Test pulse outputs	773600	773614
Max. cable length between test pulse output and input	20 m	20 m
Environmental data	773600	773614
Climatic suitability	EN 60068-2-78	EN 60068-2-78
Ambient temperature		
In accordance with the standard	EN 60068-2-14	EN 60068-2-14
Temperature range	-30 - 60 °C	-30 - 60 °C
Storage temperature		
In accordance with the standard	EN 60068-2-1/-2	EN 60068-2-1/-2
Temperature range	-40 - 70 °C	-40 - 70 °C
Climatic suitability		
In accordance with the standard	EN 60068-2-78	EN 60068-2-78
Humidity	93 % r. h. at 40 °C	93 % r. h. at 40 °C
Condensation during operation	Short-term	Short-term
EMC	EN 55011: class A, EN 61000-4-11, EN 61000-4-2, EN 61000-4-3, EN 61000-4-4, EN 61000-4-5, EN 61000-4-6, EN 61000-4-8, EN 61000-4-9	EN 55011: class A, EN 61000-4-11, EN 61000-4-2, EN 61000-4-3, EN 61000-4-4, EN 61000-4-5, EN 61000-4-6, EN 61000-4-8, EN 61000-4-9
Vibration		
In accordance with the standard	EN 60068-2-6	EN 60068-2-6
Frequency	10,0 - 55,0 Hz	10,0 - 55,0 Hz
Amplitude	0,35 mm	0,35 mm
Acceleration	1g	1g
Shock stress		
In accordance with the standard	EN 60068-2-27	EN 60068-2-27
Acceleration	15g	15g
Duration	11 ms	11 ms
In accordance with the standard	EN 60068-2-29	EN 60068-2-29
Acceleration	10g	10g
Duration	16 ms	16 ms
Airgap creepage		
In accordance with the standard	IEC 60664-1	IEC 60664-1
Overvoltage category	III	III
Pollution degree	2	2
Protection type		
In accordance with the standard	EN 60529	EN 60529
Housing	IP67	IP67
Terminals	IP67	IP67

Mechanical data	773600	773614
Material		
Top	Valox 855	Valox 855
Labelling bracket (accessories)	PC	PC
Connection type	M12	Stainless steel 1.4305
Mounting type	screw interlocked	screw interlocked
Dimensions		
Height	133,0 mm	133,0 mm
Width	60,0 mm	60,0 mm
Depth	30,0 mm	30,0 mm
Weight	250 g	250 g

Where standards are undated, the 2010-03 latest editions shall apply.

8.1 Safety characteristic data



NOTICE

You must comply with the safety-related characteristic data in order to achieve the required safety level for your plant/machine.

Unit	Operating mode	EN ISO 13849-1: 2015 PL	EN ISO 13849-1: 2015 Category	EN 62061 SIL CL	EN 62061 PFH _D [1/h]	EN ISO 13849-1: 2015 T _M [year]
Input						
SC inputs	1-channel	PL d	Cat. 2	SIL CL 2	9,06E-09	20
SC inputs	2-channel	PL e	Cat. 4	SIL CL 3	1,24E-09	20
Bus interface						
Bus interface	All	PL e	Cat. 4	SIL CL 3	1,94E-09	20

All the units used within a safety function must be considered when calculating the safety characteristic data.



INFORMATION

A safety function's SIL/PL values are **not** identical to the SIL/PL values of the units that are used and may be different. We recommend that you use the PAscal software tool to calculate the safety function's SIL/PL values.

9 Order reference

9.1 Order reference for module

Product type	Features	Order no.
PDP67 F 8DI ION	Decentralised input module	773 600
PDP67 F 8DI ION VA	Decentralised input module, V2A ring nut	773 614

9.2 Order reference for accessories

Plug

Product type	Features	Order no.
Caps for IP67 modules	Blind plug	380 324

Cable

Product type	Features		Order no.
PSS SB BUSCABLE LC	Cable, shielded	1 – 100 m	311 074
PSS67 I/O Cable	Cable	1 – 30 m	380 320
PSS67 Cable M8sf M12sm	Cable, straight M12 connector, straight M8 socket, 4-pin	3 m	380 200
PSS67 Cable M8sf M12sm	Cable, straight M12 connector, straight M8 socket, 4-pin	5 m	380 201
PSS67 Cable M8sf M12sm	Cable, straight M12 connector, straight M8 socket, 4-pin	10 m	380 202
PSS67 Cable M8sf M12sm	Cable, straight M12 connector, straight M8 socket, 4-pin	30 m	380 203
PSS67 Cable M8sf M12sm	Cable, straight M12 connector, angled M8 socket, 4-pin	3 m	380 204
PSS67 Cable M8sf M12sm	Cable, straight M12 connector, angled M8 socket, 4-pin	5 m	380 205
PSS67 Cable M8sf M12sm	Cable, straight M12 connector, angled M8 socket, 4-pin	10 m	380 206
PSS67 Cable M8sf M12sm	Cable, straight M12 connector, angled M8 socket, 4-pin	30 m	380 207
PSS67 Cable M12sf M12sm	Cable, straight M12 connector, straight M12 socket, 5-pin	3 m	380 208
PSS67 Cable M12sf M12sm	Cable, straight M12 connector, straight M12 socket, 5-pin	5 m	380 209
PSS67 Cable M12sf M12sm	Cable, straight M12 connector, straight M12 socket, 5-pin	10 m	380 210

Product type	Features		Order no.
PSS67 Cable M12sf M12sm	Cable, straight M12 connector, straight M12 socket, 5-pin	30 m	380 211
PSS67 Cable M12sf M12sm	Cable, angled M12 connector, angled M12 socket, 5-pin	3 m	380 212
PSS67 Cable M12sf M12sm	Cable, angled M12 connector, angled M12 socket, 5-pin	5 m	380 213
PSS67 Cable M12sf M12sm	Cable, angled M12 connector, angled M12 socket, 5-pin	10 m	380 214
PSS67 Cable M12sf M12sm	Cable, angled M12 connector, angled M12 socket, 5-pin	30 m	380 215

Adapter

Product type	Features	Order no.
PSEN ma adapter	Adapter for connection to safety switch PSEN-mag and PIT en1.0	380 300
PSEN cs adapter	Adapter for connection to safety switch PSEN-code	380 301

Connector

Product type	Features	Order no.
PSS67 M12 connector	Connector, M12, straight, 5-pin, A-coded	380 308
PSS67 M12 connector	Socket, M12, straight, 5-pin, A-coded	380 309
PSS67 M12 connector	Connector, M12, angled, 5-pin, A-coded	380 310
PSS67 M12 connector	Socket, M12, angled, 5-pin, A-coded	380 311

► Support

Technical support is available from Pilz round the clock.

Americas

Brazil
+55 11 97569-2804

Canada
+1 888-315-PILZ (315-7459)

Mexico
+52 55 5572 1300

USA (toll-free)
+1 877-PILZUSA (745-9872)

Asia

China
+86 21 60880878-216

Japan
+81 45 471-2281

South Korea
+82 31 450 0680

Australia

+61 3 95446300

Europe

Austria
+43 1 7986263-0

Belgium, Luxembourg
+32 9 3217575

France
+33 3 88104000

Germany
+49 711 3409-444

Ireland
+353 21 4804983

Italy
+39 0362 1826711

Scandinavia

+45 74436332

Spain

+34 938497433

Switzerland

+41 62 88979-30

The Netherlands

+31 347 320477

Turkey

+90 216 5775552

United Kingdom

+44 1536 462203

You can reach our international hotline on:

+49 711 3409-444
support@pilz.com

Pilz develops environmentally-friendly products using ecological materials and energy-saving technologies. Offices and production facilities are ecologically designed, environmentally-aware and energy-saving. So Pilz offers sustainability, plus the security of using energy-efficient products and environmentally-friendly solutions.

Energy saving by Pilz



Pilz GmbH & Co. KG
Felix-Wankel-Straße 2
73760 Ostfildern, Germany
Tel.: +49 711 3409-0
Fax: +49 711 3409-133
info@pilz.com
www.pilz.com

PILZ
THE SPIRIT OF SAFETY