

Inductive sensor

NBB10-30GM50-E3-V1



■ Basic series



Dimensions

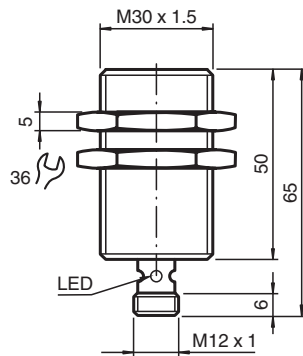

Technical Data

General specifications		
Switching function		Normally closed (NC)
Output type		PNP
Rated operating distance	s_n	10 mm
Installation		flush
Output polarity		DC
Assured operating distance	s_a	0 ... 8.1 mm
Reduction factor r_{Al}		0.3
Reduction factor r_{Cu}		0.3
Reduction factor r_{304}		0.8
Nominal ratings		
Operating voltage	U_B	10 ... 30 V
Switching frequency	f	0 ... 200 Hz
Hysteresis	H	typ. 5 %
Reverse polarity protection		reverse polarity protected
Short-circuit protection		pulsing

Release date: 2020-03-20 Date of issue: 2020-03-30 Filename: 087896_eng.pdf

Refer to "General Notes Relating to Pepperl+Fuchs Product Information".

Pepperl+Fuchs Group
www.pepperl-fuchs.com

USA: +1 330 486 0001
fa-info@us.pepperl-fuchs.com

Germany: +49 621 776 1111
fa-info@de.pepperl-fuchs.com

Singapore: +65 6779 9091
fa-info@sg.pepperl-fuchs.com

PEPPERL+FUCHS

Technical Data

Voltage drop	U_d	$\leq 3 \text{ V}$
Operating current	I_L	0 ... 200 mA
Off-state current	I_r	0 ... 0.5 mA typ. 0.1 μA at 25 °C
No-load supply current	I_0	$\leq 20 \text{ mA}$
Switching state indicator		Multihole-LED, yellow
Functional safety related parameters		
MTTF _d		1920 a
Mission Time (T_M)		20 a
Diagnostic Coverage (DC)		0 %
Compliance with standards and directives		
Standard conformity		
Standards		EN 60947-5-2:2007 IEC 60947-5-2:2007
Approvals and certificates		
UL approval		cULus Listed, General Purpose
CSA approval		cCSAus Listed, General Purpose
CCC approval		CCC approval / marking not required for products rated $\leq 36 \text{ V}$
Ambient conditions		
Ambient temperature		-25 ... 70 °C (-13 ... 158 °F)
Mechanical specifications		
Connection type		Connector M12 x 1 , 4-pin
Housing material		brass, nickel-plated
Sensing face		PBT
Degree of protection		IP67

Connection

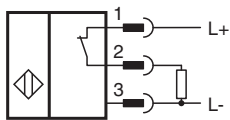



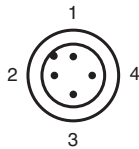

Connection Assignment



Wire colors in accordance with EN 60947-5-2

1	BN	(brown)
2	WH	(white)
3	BU	(blue)
4	BK	(black)

Accessories

	BF 30	Mounting flange, 30 mm
	EXG-30	Quick mounting bracket with dead stop
	V1-G-2M-PUR	Female cordset, M12, 4-pin, PUR cable
	V1-W-2M-PUR	Female cordset, M12, 4-pin, PUR cable