

Inductive sensor NBB20-L2-E2-C-V1

- Sensor head bidirectional and rotatable
- 20 mm flush
- 3-wire DC
- Weld Immune
- Quick mounting bracket
- 4-way LED indicator

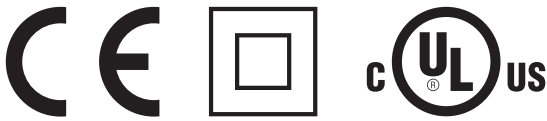

Dimensions

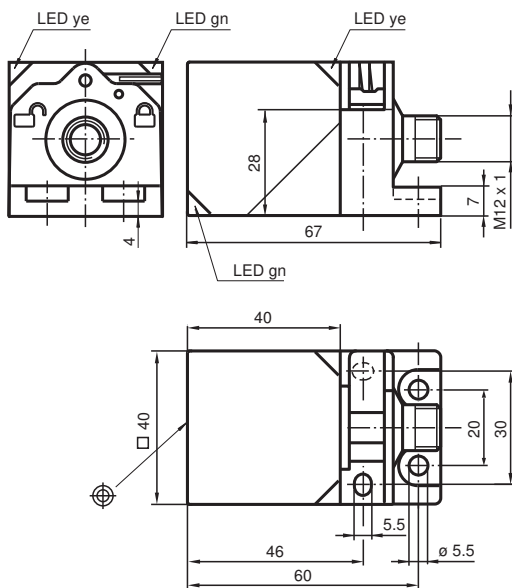

Technical Data

General specifications

Switching function		Normally open (NO)
Output type		PNP
Rated operating distance	s_n	20 mm
Installation		flush
Output polarity		DC
Assured operating distance	s_a	0 ... 16.2 mm
Actual operating distance	s_r	18 ... 22 mm
Reduction factor r_{Al}		0.33
Reduction factor r_{Cu}		0.31
Reduction factor r_{304}		0.74
Reduction factor r_{Brass}		0.41
Output type		3-wire

Release date: 2020-03-21 Date of issue: 2020-03-30 Filename: 132786_eng.pdf

Refer to "General Notes Relating to Pepperl+Fuchs Product Information".

Pepperl+Fuchs Group
www.pepperl-fuchs.com

USA: +1 330 486 0001
fa-info@us.pepperl-fuchs.com

Germany: +49 621 776 1111
fa-info@de.pepperl-fuchs.com

Singapore: +65 6779 9091
fa-info@sg.pepperl-fuchs.com

 PEPPERL+FUCHS

Technical Data

Nominal ratings

Operating voltage	U_B	10 ... 30 V DC
Switching frequency	f	0 ... 5 Hz
Hysteresis	H	typ. 5 %
Reverse polarity protection		reverse polarity protected
Short-circuit protection		pulsing
Voltage drop	U_d	≤ 3 V
Operating current	I_L	0 ... 200 mA
Off-state current	I_r	0 ... 0.5 mA
No-load supply current	I_0	≤ 20 mA
Time delay before availability	t_v	300 ms
Operating voltage indicator		LED, green
Switching state indicator		LED, yellow

Functional safety related parameters

MTTF _d		1170 a
Mission Time (T _M)		20 a
Diagnostic Coverage (DC)		0 %

Compliance with standards and directives

Standard conformity		
Standards		EN 60947-5-2:2007 EN 60947-5-2/A1:2012 IEC 60947-5-2:2007 IEC 60947-5-2 AMD 1:2012

Approvals and certificates

Protection class		II
Rated insulation voltage	U_i	253 V
Rated impulse withstand voltage	U_{imp}	4000 V
UL approval		cULus Listed, General Purpose
CCC approval		CCC approval / marking not required for products rated ≤ 36 V

Ambient conditions

Ambient temperature		-25 ... 85 °C (-13 ... 185 °F)
Storage temperature		-25 ... 85 °C (-13 ... 185 °F)

Mechanical specifications

Connection type		Connector plug M12 x 1 , 4-pin
Housing material		PA
Sensing face		PA
Degree of protection		IP69K
Mass		130 g

Connection

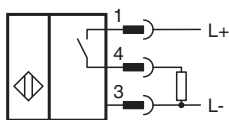





Connection Assignment



Wire colors in accordance with EN 60947-5-2

1	BN	(brown)
2	WH	(white)
3	BU	(blue)
4	BK	(black)

Accessories

	V1-G-2M-PUR	Female cordset, M12, 4-pin, PUR cable
	V1-W-2M-PUR	Female cordset, M12, 4-pin, PUR cable
	MHW 01	Modular mounting bracket
	MH 02-L	Mounting aid

Release date: 2020-03-21 Date of issue: 2020-03-30 Filename: 132786_eng.pdf

Refer to "General Notes Relating to Pepperl+Fuchs Product Information".