

# Inductive sensor

## NBB20-L2-Z4-V1

- Sensor head bidirectional and rotatable
- 20 mm flush
- 2-wire DC
- Quick mounting bracket



### Dimensions

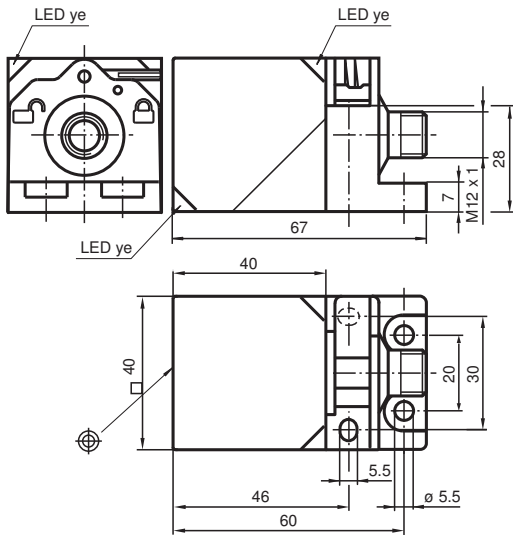

### Technical Data

#### General specifications

Switching function		Normally open (NO)
Output type		Two-wire
Rated operating distance	$s_n$	20 mm
Installation		flush
Output polarity		DC
Assured operating distance	$s_a$	0 ... 16.2 mm
Actual operating distance	$s_r$	18 ... 22 mm
Reduction factor $r_{Al}$		0.33
Reduction factor $r_{Cu}$		0.31
Reduction factor $r_{304}$		0.74
Reduction factor $r_{Brass}$		0.41

#### Nominal ratings

Operating voltage	$U_B$	3.8 ... 30 V DC
Switching frequency	f	0 ... 30 Hz
Reverse polarity protection		reverse polarity protected
Short-circuit protection		pulsing
Voltage drop	$U_d$	$\leq 3.8$ V

Release date: 2020-03-23 Date of issue: 2020-03-30 Filename: 182171\_eng.pdf

Refer to "General Notes Relating to Pepperl+Fuchs Product Information".

Pepperl+Fuchs Group  
www.pepperl-fuchs.com

USA: +1 330 486 0001  
fa-info@us.pepperl-fuchs.com

Germany: +49 621 776 1111  
fa-info@de.pepperl-fuchs.com

Singapore: +65 6779 9091  
fa-info@sg.pepperl-fuchs.com

**PF** PEPPERL+FUCHS

## Technical Data

Voltage drop at $I_L$			
Voltage drop $I_L = 100$ mA, switching element on	$U_d$	...	3.8 V
Operating current	$I_L$	2 ...	100 mA
Off-state current	$I_r$	0 ...	0.5 mA
Switching state indicator		LED, yellow	
<b>Compliance with standards and directives</b>			
Standard conformity			
Standards		EN 60947-5-2:2007	IEC 60947-5-2:2007
<b>Approvals and certificates</b>			
UL approval		cULus Listed, General Purpose	
CSA approval		cCSAus Listed, General Purpose	
CCC approval		CCC approval / marking not required for products rated $\leq 36$ V	
<b>Ambient conditions</b>			
Ambient temperature		-25 ... 70 °C (-13 ... 158 °F)	
Storage temperature		-25 ... 85 °C (-13 ... 185 °F)	
<b>Mechanical specifications</b>			
Connection type		Connector M12 x 1 , 4-pin	
Housing material		PA	
Sensing face		PA	
Degree of protection		IP69K	
Mass		130 g	

## Connection

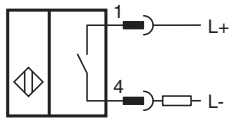



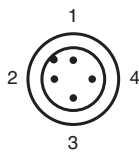

## Connection Assignment



Wire colors in accordance with EN 60947-5-2

1	BN	(brown)
2	WH	(white)
3	BU	(blue)
4	BK	(black)

## Accessories

	<b>V1-G-2M-PUR</b>	Female cordset, M12, 4-pin, PUR cable
	<b>V1-W-2M-PUR</b>	Female cordset, M12, 4-pin, PUR cable
	<b>MHW 01</b>	Modular mounting bracket
	<b>MH 02-L</b>	Mounting aid