



- For the intrinsically safe operation of a wide range of devices, such as HART transmitters, solenoid valves, sensors, zero-potential contacts and many more
- Compact, space-saving devices that are easy to install on a DIN rail
- Quick to install as barriers can be simultaneously snapped onto rail and connected to PE

WebCode **9002A**



The 9002 series INTRINSPAK two-channel safety barriers enable the intrinsically safe operation of virtually all field devices. The comprehensive portfolio and the combination of safety barriers cover a wide variety of signals. The devices are incredibly robust and require very little space. The back-up fuse is a convenient feature as it is standardised for all variants.

Technical Data

Explosion Protection

Application range (zones)	2 22
Ex interface zone	0 1 2 20 21 22
Certificate IECEx Gas	IECEX PTB 08.0057X
Certificate ATEX Gas	PTB 01 ATEX 2053 X
Certificate IECEx Dust	IECEX PTB 08.0057X
Certificate ATEX Dust	PTB 01 ATEX 2053 X
Gas explosion protection IECEx	Ex nA [ia Ga] IIC/IIB T4 Gc
Gas explosion protection ATEX	⊕ II 3 (1) G Ex nA [ia Ga] IIC/IIB T4 Gc
Dust explosion protection IECEx	[Ex ia Da] IIIC
Dust explosion protection ATEX	⊕ II (1) D [Ex ia Da] IIIC
Certificates	ATEX (PTB), Brazil (ULB), Canada (CSA), China (CQST), EAC (STV), IECEx (PTB), Korea (KGS), USA (FM), USA (UL)
EAC certificate	TS RU S-DE.GB04.B.00134
Installation	in Zone 2, Division 2 and in safe area

Safety Data

Max. voltage U_o	26 V
Max. voltage U_o	26 V 20 V 26 V
Max. current I_o	87 mA
Max. power P_o	540 mW
Max. permissible external capacitance C_o for IIC	0.099 μ F

Safety Barriers

Dual-channel safety barrier



9002/00-260-138-001 Art. No. 158867

Safety Data

Max. permissible external capacitance C_o for IIB	0.77 μ F
Max. permissible external inductance L_o for IIC	2.7 mH
Max. permissible external inductance L_o for IIB	15.4 mH
Further information	see respective certificate and operating instructions

Electrical Data

Number of channels	2					
Channel	1 2 1 + 2					
Nominal voltage U_N	22,5 V 17.5 V					
Min. resistance R_{min}	321 Ω 416 Ω					
Max. resistance R_{max}	358 Ω 463 Ω					
Max. current I_o	87 mA 51 mA 138 mA					
Max. power P_o	540 mW 245 mW 785 mW					
DC rated operational voltage	17.5 V					
Power supply	Controlled, nominal voltage					
Nominal voltage	22,5 V					
Maximum resistance R_{max}	358 Ω					
Minimum resistance R_{min}	321 Ω					
Maximum output current I_{max}	62 mA					
Potential	Negative potential					
Potential Ch 1	Negative potential					
Potential Ch 2	Negative potential					
Ohm.curr.lim.usingfreq.>= 50mA	\leq 100 kHz					
Ohm.curr.lim.usingfreq<= 50 mA	\leq 50 kHz					
Ileak leakage current for U_N	\leq 2 μ A					
Ileak leakage current for U_N 2	(Unless specified otherwise)					
Channel	Nominal voltage U_N	Min. resistance R_{min}	Max. resistance R_{max}	Max. voltage U_o	Max. current I_o	Max. power P_o
1	22,50 V	321.00 Ω	358.00 Ω	26.00 V	87.0 mA	540.000 mW
2	17.50 V	416.00 Ω	463.00 Ω	20.00 V	51.0 mA	245.000 mW
1 + 2				26.00 V	138.0 mA	785.000 mW

Ambient Conditions

Min. ambient temperature	-20 $^{\circ}$ C
--------------------------	------------------

9002/00-260-138-001 Art. No. 158867

Ambient Conditions

Max. ambient temperature	+60 °C
Ambient temperature	-20 °C ... +60 °C
Min. storage temperature	-20 °C
Max. storage temperature	+75 °C
Storage temperature	-20 °C ... +75 °C
Maximum relative humidity	95% on av., no condensation
Temperature influence	≤ 0,25 %/10K

Mechanical Data

Degree of protection (IP)	IP40
Degree of protection (IP) Terminals	IP20
Enclosure material	Polyamide 6GF
Number of connection terminals	4
Max. clamping range	1.5 mm ²
Connection cross-section	4 mm ²
Type of connection cable	Solid Finely stranded
Width	103 mm
Length	12 mm
Mounting depth	72 mm
Weight	0.11 kg

Mounting / Installation

Connection type	2 PA
-----------------	------

Technical Drawings

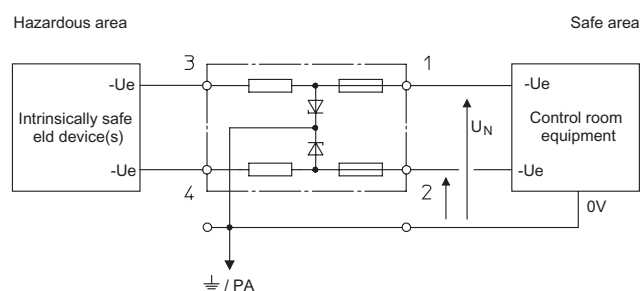

Two-channel safety barriers, potential: - / -

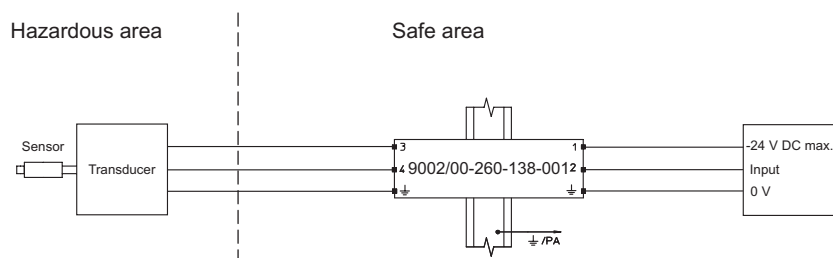

Application: Vibration sensor

9002/00-260-138-001 Art. No. 158867

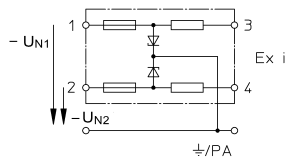

Picture C

Dimensional Drawings (All Dimensions in mm [inches]) – Subject to Alterations

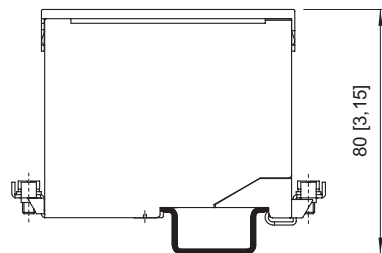
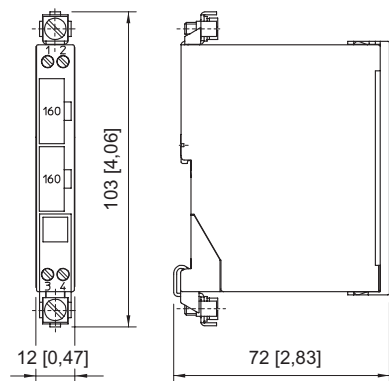

Mounting on DIN rail NS 35/15

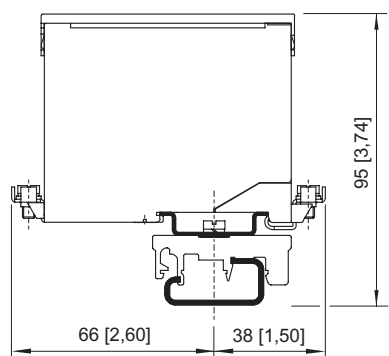

Mounting on DIN rail NS 32 by means of adaptor and mounting attachment, moulded plastic

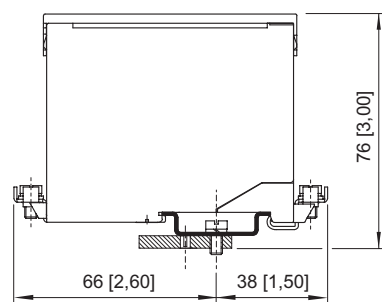

Mounting on mounting plate by means of adaptor

Accessories and Spare Parts

Back-up fuse



For all safety barriers Series 9001, 9002 and 9004
unit: 5 pcs.

Art. No.

158964

Holder for label

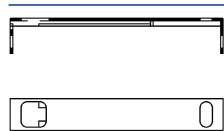

Transparent cover for labelling

Art. No.

158977

Labelling paper

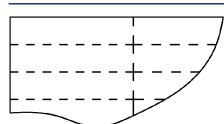

Perforated, for typing
Format: DIN A4
Packaging unit: 80 pieces

Art. No.

158973

9002/00-260-138-001 Art. No. 158867

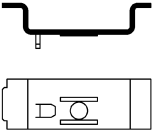
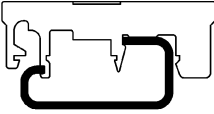
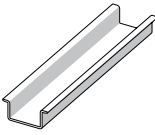
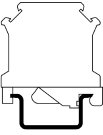
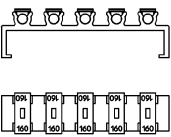
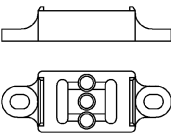
Adaptor		Art. No.
	Adaptor allows installation of a safety barrier Series 900x on a mounting plate of a previous series.	158826
Mounting attachment moulded plastic		Art. No.
	Enables mounting of safety barrier on a G-rail.	165283
DIN rail		Art. No.
	NS35/15 (meter length)	103714
Earth terminal		Art. No.
	USLKG 5 (wire range 4 mm ²) Terminal enables connection of protective conductors to DIN rail. Colour green-yellow.	112760
	USLKG 6 N (wire range 6 mm ²) Terminal enables connection of protective / earthing conductors to DIN rail. Colour green-yellow.	112599
Fuse holder		Art. No.
	Fuse holder is snapped onto the side of the safety barrier and can be equipped with up to 5 back-up fuses (replacement).	158834
Insulating stand off		Art. No.
	Suitable for DIN rail NS35/15, allows electrically insulated mounting of DIN rail from mounting plate.	158828

We reserve the right to make alterations to the technical data, dimensions, weights, designs and products available without notice. The illustrations cannot be considered binding.