**User's
Manual**

**Models
UT150, UT152, UT155
Temperature Controllers**



IM 05C01E12-41E

Note: This user's manual (IM 05C01E12-41E) is a re-edited, A4-size version of the IM 05C01E12-01E user's manual that is supplied along with the product shipped. Therefore, both manuals have the same contents, except for some minor differences in the cross-referenced page numbers.

Revision Record

●Manual No. : IM 05C01E12-41E(4th Edition)

●Title : Models UT150,UT152,UT155 Temperature Controllers

Edition	Date	Revised Item
First	Nov.,2000	Newly published
Second	Mar.,2001	Correct
Third	Sep.,2003	Correct
Fourth	Jun.,2004	Change of the company name.

Please read through this user’s manual to ensure correct usage of the controller and keep it handy for quick reference.

CONTENTS

1. Notice	2
2. What is on the Front Panel?	3
3. Installing the Controller	4
4. Panel Cutout Dimensions and External Dimensions.....	5
5. Wiring	6
6. Hardware Specifications	9
7. Key Operations	11
8. Troubleshooting	20

■ Checking Package Contents

Before using the product, check that its model & suffix codes are as you ordered.

Model and Suffix Codes

Model	Suffix code	Description
UT150 UT152 UT155		Temperature controller
Control output for standard type (or for heating)	-R -V -A	Relay output (time-proportional PID or on/off control) Voltage pulse output (time-proportional PID) 4 to 20mA output (continuous PID)
Control output for cooling	N R V A	No cooling output (standard type) Relay output (time-proportional PID or on/off control) Voltage pulse output (time-proportional PID) 4 to 20mA output (continuous PID)
Option	/AL /HBA /EX /RET /RS /V24	Alarm outputs (2 points) Heater disconnection alarm (includes optional /AL function) SP1/SP2 switching, starting of timer, and RUN/STOP switching by external contacts PV retransmission output in 4 to 20mA Communication function Power Supply 24V DC / 24V AC

Note: When specifying the /RS option, be sure to order the required number of copies of Communication Functions User’s Manual separately.

Check the package contents against the list below.

- Temperature controller
- Mounting bracket 1 for UT150
2 for UT152, UT155
- User’s manual (IM 05C01E12-01E)

1. NOTICE

The following safety symbol is used both on the product and in this user's manual.



This symbol stands for "Handle with Care." When displayed on the product, the operator should refer to the corresponding explanation given in the user's manual in order to avoid injury or death of personnel and/or damage to the product. In the manual the symbol is accompanied by an explanation of the special care that is required to avoid shock or other dangers that may result in injury or loss of life.

The following symbols are used in this manual only.



NOTE

Indicates that operating the hardware or software in a particular manner may lead to damage or result in system failure.



IMPORTANT





Draws attention to information that is essential for understanding the operation and/or features of the product.

■ Exemption from Responsibility

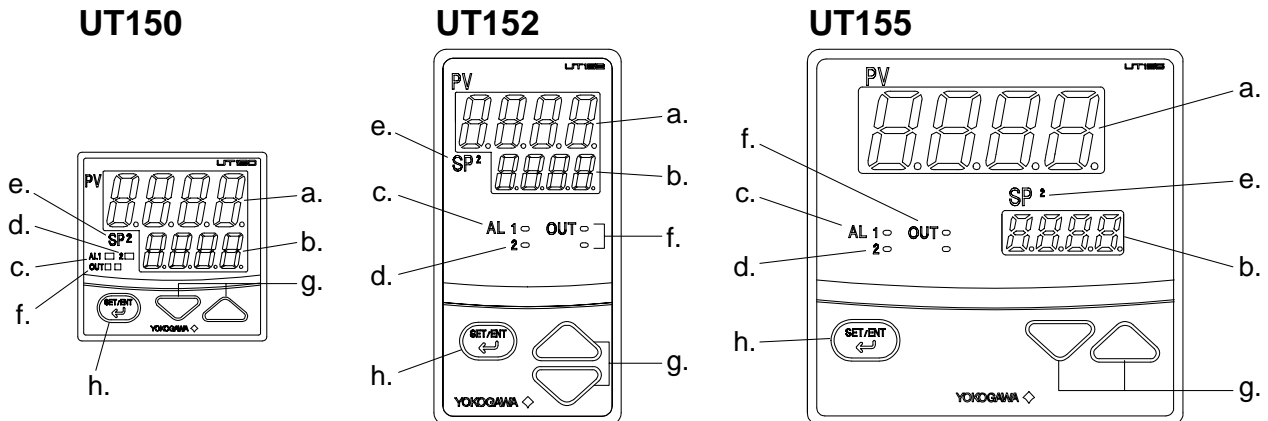
Make sure that all of the precautions are strictly adhered to. Yokogawa Electric Corporation assumes no liability for any damage resulting from use of the instrument in contradiction to the precautions. Also, Yokogawa Electric Corporation assumes no liability to any party for any loss or damage, direct or indirect, caused by the use or any unpredictable defect of the instrument.

2. WHAT IS ON THE FRONT PANEL?



	Name	Function
a.	PV display (red)	Indicates PV (measured value) and character information such as parameter codes and error codes.
b.	SP display (green)	Indicates SP (target setpoint) and parameter values.
c.	Alarm 1 (AL1) lamp (red)	Lit when alarm 1 is activated.
d.	Alarm 2 (AL2) lamp (red)	Lit when alarm 2 is activated.
e.	SP2 lamp (green)	Lit when SP2 is being used for control operation.
f.	Output (OUT) display lamps UT150: (Left: orange; right: green) UT152, UT155: (Upper: orange; lower: green)	Lit while control output is being output. <ul style="list-style-type: none"> The left (upper) lamp is lit in orange during control output of standard type. In heating/cooling control, the left (upper) lamp lights up in orange when the heating-side output is active; while the right (lower) lamp lights up in green when the cooling-side output is active.
g.	Data change keys (Indicated as simply the  and  keys hereafter.)	<ul style="list-style-type: none"> Changes SP and the parameter values. Pressing the  key decreases the data value and pressing the  key increases it. Holding down the key will gradually increase the speed of the change.
h.	SET/ENT key (data registering key) (Indicated as simply the  key hereafter.)	<ul style="list-style-type: none"> Registers the data value changed using the data change keys. Switches between operating displays or parameter setting displays sequentially. Pressing the key for 3 seconds or longer in the operating display retrieves the operating parameter setting display. Pressing the key for 3 seconds or longer in either an operating or setup parameter setting display transfers back to operating display 1. (See Page 13.)

3. INSTALLING THE CONTROLLER



CAUTION

To prevent electric shock, the source of power to the controller must be turned off when mounting the controller on to a panel.



NOTE

To install the controller, select a location where:

1. No-one may accidentally touch the terminals;
2. Mechanical vibrations are minimal;
3. Corrosive gas is minimal;
4. The temperature can be maintained at about 23°C with minimal fluctuation;
5. There is no direct heat radiation;
6. There are no resulting magnetic disturbances;
7. The terminal board (reference junction compensation element, etc.) is protected from wind;
8. There is no splashing of water; and
9. There are no flammable materials.

Never place the controller directly on flammable items.

If the controller has to be installed close to flammable items or equipment, be sure to enclose the controller in shielding panels positioned at least 150mm away from each side. These panels should be made of either 1.43mm thick metal-plated steel plates or 1.6mm thick uncoated steel plates.

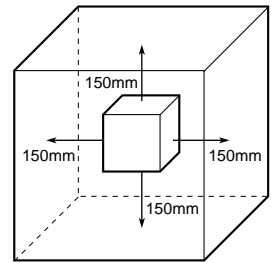

- Mount the controller at an angle within 30° from horizontal with the screen facing upward. Do not mount it facing downward.

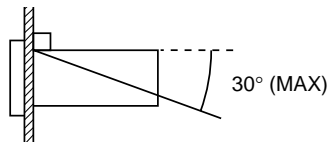

■ Mounting the Controller

<p>UT150</p> <ol style="list-style-type: none"> 1. Affix the bracket over the back end of the controller. 2. Push the bracket to the panel, and then secure the bracket into position. <p>Panel</p> <p>UT150</p> <p>Bracket</p> <p>[How to remove the bracket] To move the bracket, push down the center of the upper and lower parts of the controller softly. The bracket is released from the latch.</p>	<p>UT152, UT155</p> <p>Panel</p> <p>Large bracket (top)</p> <p>Terminal board</p> <p>Direction for mounting</p> <p>Small bracket (bottom)</p> <p>Insert a screwdriver into the brackets to tighten the screws.</p> <p>Insert the controller into the opening with the terminal board facing the front. Set and tighten the top and bottom brackets on the controller to fix it on the</p>
--	--

4. PANEL CUTOUT DIMENSIONS AND EXTERNAL DIMENSIONS



NOTE

Splash-proof construction is not available when the side-by-side close mounting method shown in the following figures, is chosen for any of the controllers.

1. General Mounting

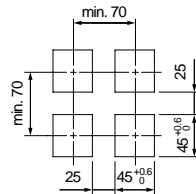

UT150

Unit: mm

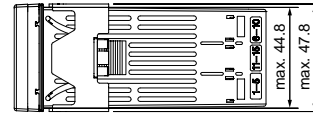

2. Side-by-side Close Mounting

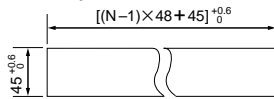

N is the number of controllers.
If $N \geq 5$, then measure the actual length.

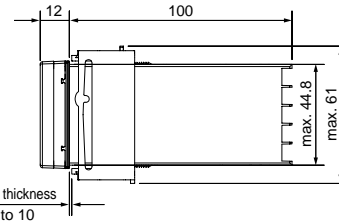
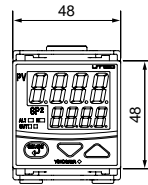

Panel thickness
1 to 10

1. General Mounting

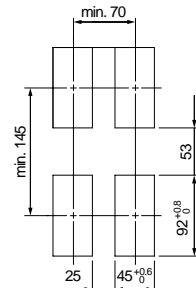

UT152

Unit: mm

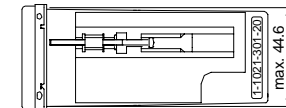

2. Side-by-side Close Mounting

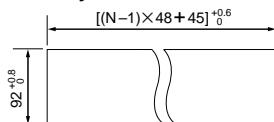

N is the number of controllers.
If $N \geq 5$, then measure the actual length.

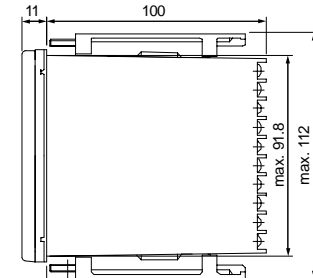
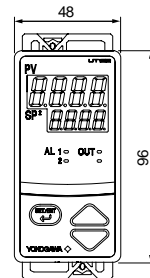

Panel thickness
1 to 10

1. General Mounting

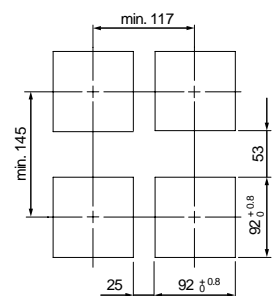

UT155

Unit: mm

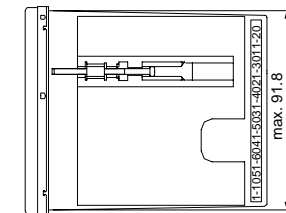

2. Side-by-side Close Mounting

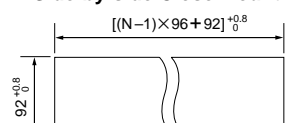

N is the number of controllers.
If $N \geq 5$, then measure the actual length.

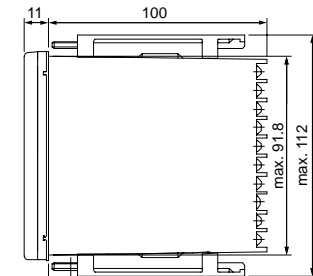
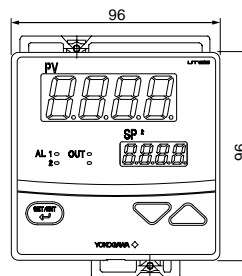

Panel thickness
1 to 10

5. WIRING



CAUTION

- 1) Before you start wiring, turn off the power source and use a tester to check that the controller and cables are not receiving any power in order to prevent electric shock.
- 2) For safety, be sure to install a circuit breaker switch (of 5A and 100V AC or 220V AC, and that conforms to IEC60947) near the instrument so as to be operated easily, and clearly indicate that the device is used to de-energize the instrument.
- 3) Wiring should be carried out by personnel with appropriate electrical knowledge and experience.



IMPORTANT

- 1) Use a single-phase power source. If the source has a lot of noise, use an isolation transformer for the primary side and a line filter (we recommend TDK's ZAC2205-00U product) for the secondary side. When this noise-prevention measure is taken, keep the primary and secondary power cables well apart. Since the controller has no fuse, be sure to install a circuit breaker switch (of 5A and 100V AC or 220V AC, and that conforms to IEC standards) and clearly indicate that the device is used to de-energize the controller.
- 2) For thermocouple input, use shielded compensating lead wires. For RTD input, use shielded wires which have low resistance and no resistance difference between the 3 wires. See the table given later for the specifications of the cables and terminals and the recommended products.
- 3) The control output relay cannot be replaced even though it has a limited service life (100,000 relay contacts for the resistance load). Thus, an auxiliary relay should be used so that the load can be turned on and off.
- 4) When using an inductive load (L) such as an auxiliary relay and solenoid valve, be sure to insert a CR filter (for AC) or diode (for DC) in parallel as a spark-rejecting surge suppressor to prevent malfunctions or damage to the relay.
- 5) When there is the possibility of being struck by external lightning surge, use the arrester to protect the instrument.



NOTE

- Always fix a terminal cover bracket to the UT150 controller before wiring if an optional anti-electric-shock terminal cover (part number: L4000FB) is used.
- Two types of optional anti-electric-shock terminal covers (part numbers T9115YE and T9115YD) are available for the UT152 and UT155 controllers, respectively.

● Cable Specifications and Recommended Products

Power supply and relay contact output	600V vinyl insulated wire/cable, JIS C3307, 0.9 to 2.0mm ²
Thermocouple input	Shielded compensating lead wire, JIS C1610
RTD input	Shielded wire (3-wire), UL2482 (Hitachi cable)
Other signals	Shielded wire

● Recommended Terminals

Use M3.5 screw-compatible crimp-on terminals with an insulating sleeve, as shown below.

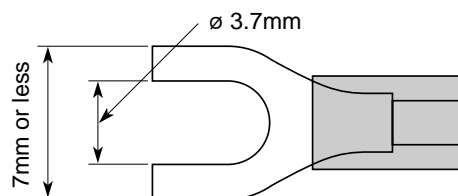
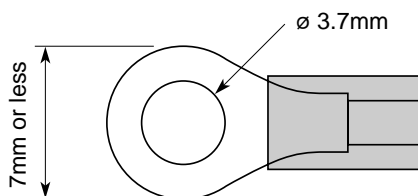

IM 05C01E12-41E

■ UT150 Terminal Arrangement (Standard type)

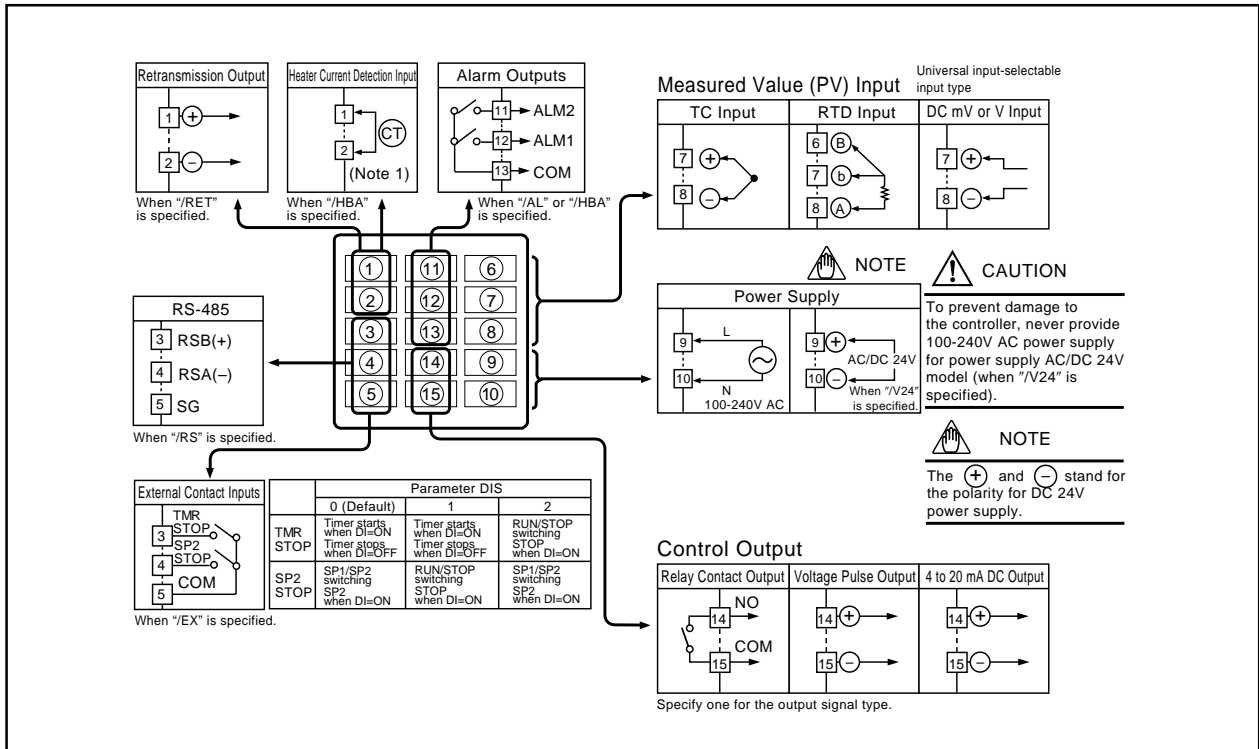

■ UT150 Terminal Arrangement (Heating/cooling type)

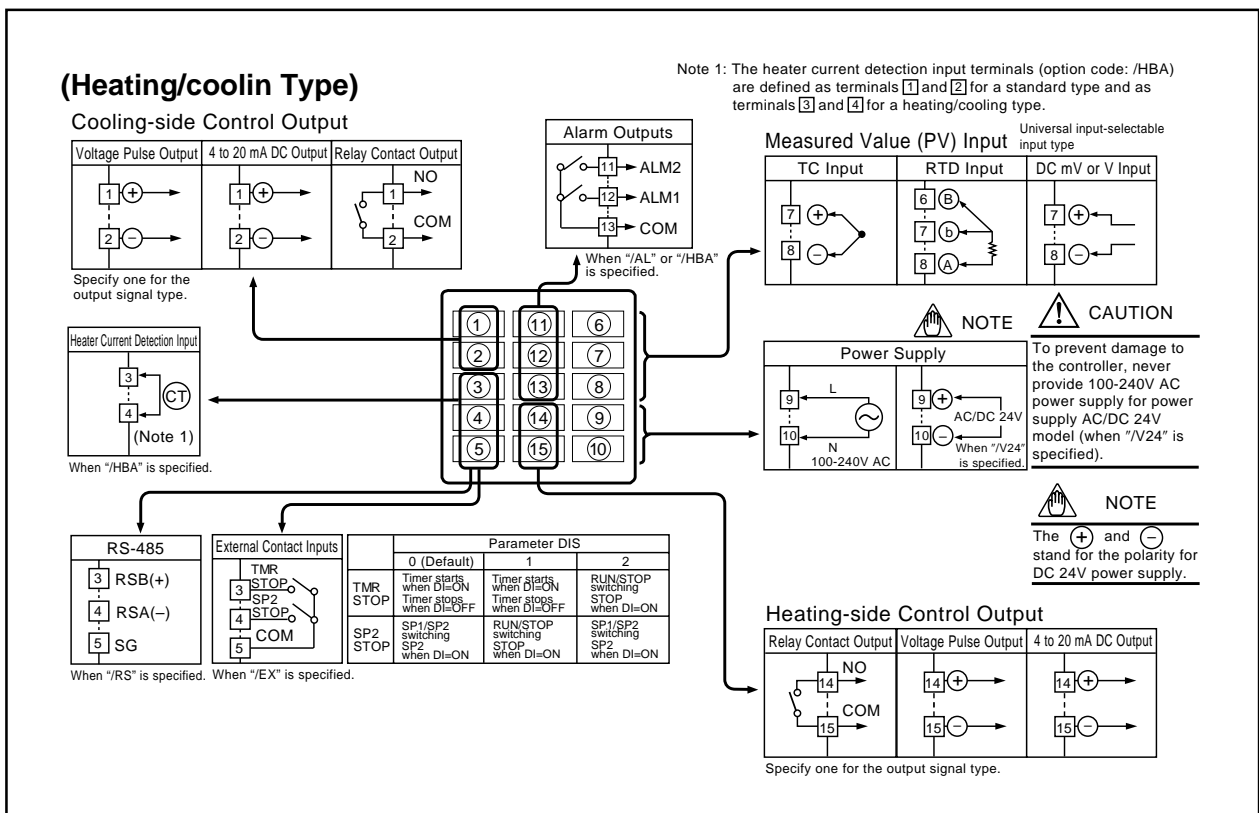

■ UT152/UT155 Terminal Arrangement (Standard type)

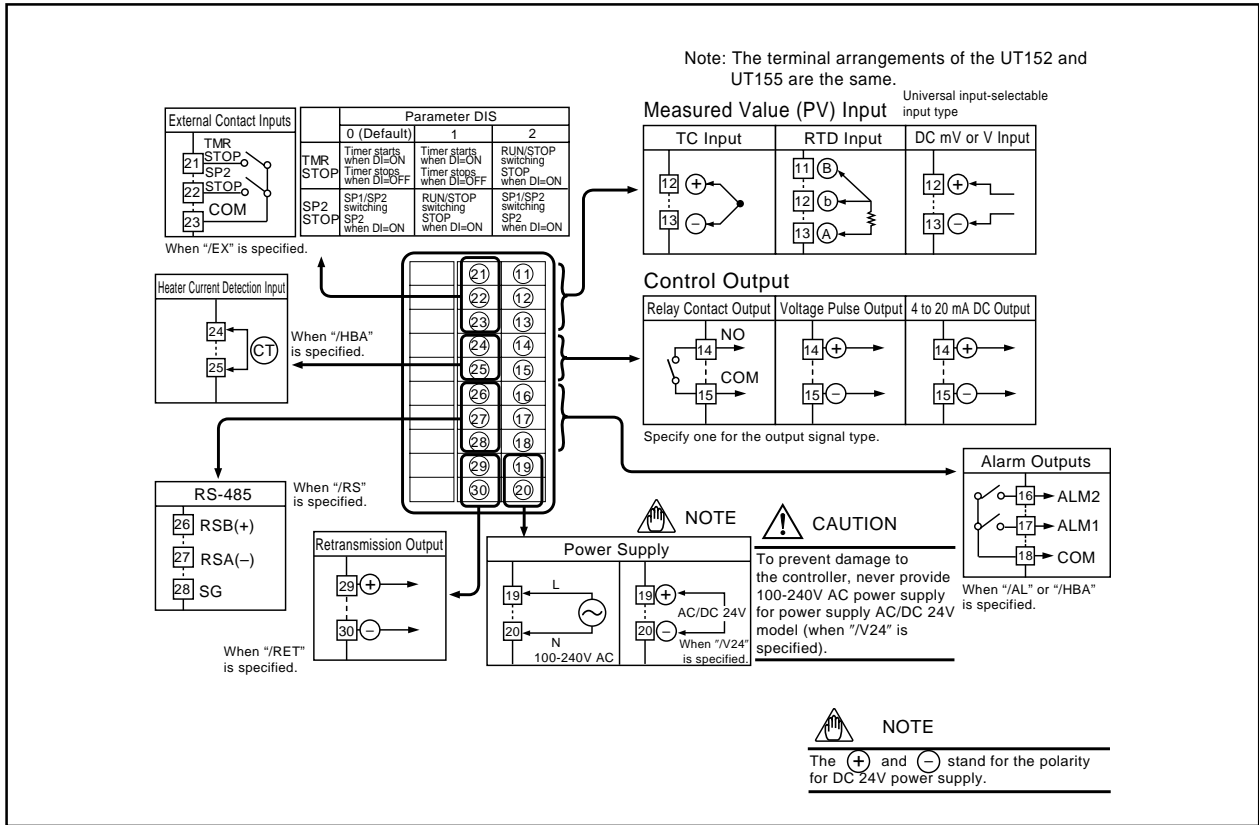

■ UT152/UT155 Terminal Arrangement (Heating/cooling type)

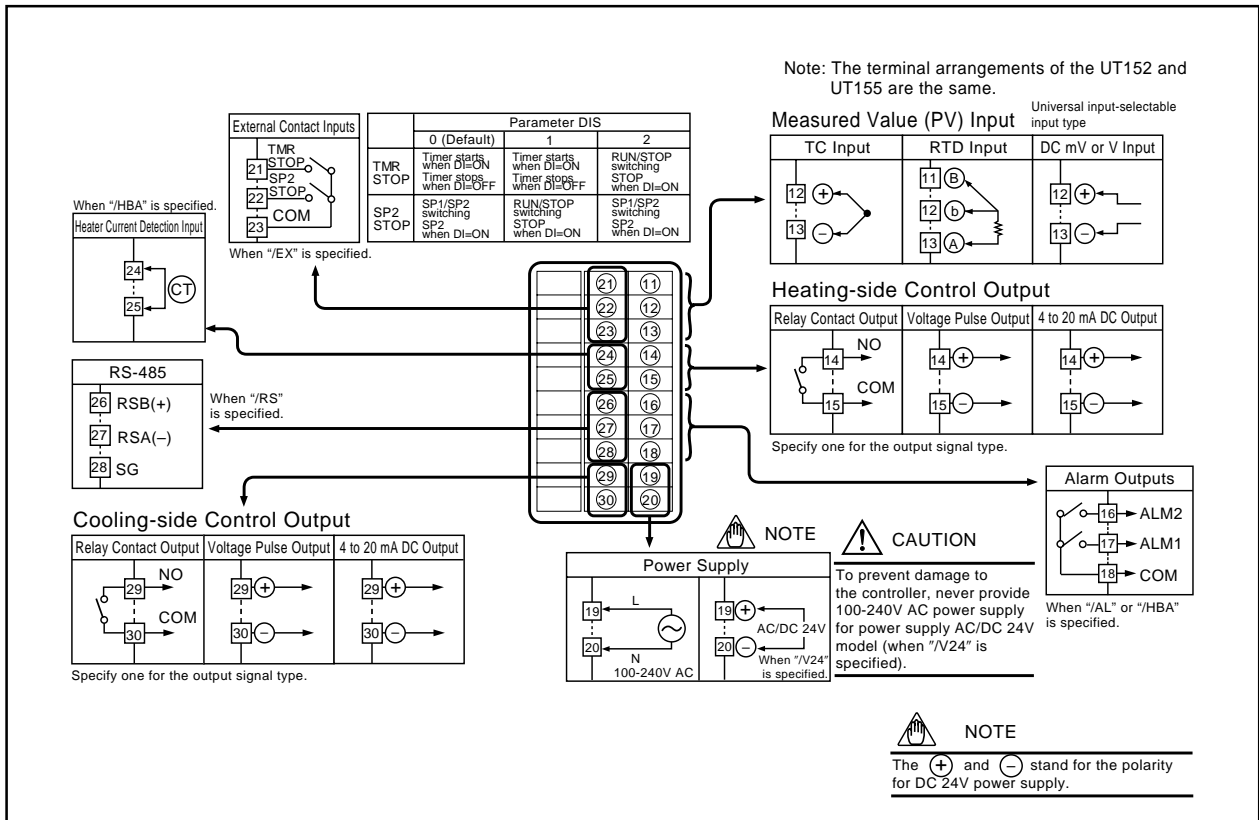

6. HARDWARE SPECIFICATIONS

Measured Value Input

- Input: 1 point
- Input type: Universal; can be selected by software
- Input accuracy (at 23 ±2°C ambient temperature)
 - Thermocouple: ±2°C±1digit
 However,
 - ±4°C for thermocouple input -200 to -100°C
 - ±3°C for thermocouple input -100 to 0°C
 - ±5°C for type R and S (±9°C for 0 to 500°C)
 - ±9°C for type B (accuracy is not guaranteed for 0 to 400°C)
- RTD: ±1°C±1digit
- Voltage (mV, V): ±0.3%±1digit
- Sampling period for measured value input: 500ms
- Burn-out detection: Functions for thermocouple or RTD input (burn-out upscale only; cannot be switched off)
- Input resistance: 1MΩ or greater for thermocouple or DC mV input. Approx. 1MΩ for DC V input
- Maximum allowable signal source resistance :
 - 250Ω for thermocouple or DC mV input
 - 2kΩ for DC V input
- Maximum allowable wiring resistance for RTD input: 10Ω/wire (The resistance values of three wires must be the same.)
- Allowable input voltage: ±10V DC for thermocouple or DC mV input
 - ±20V DC for DC V input
- Noise rejection ratio: Normal mode noise: Min. 40dB (50/60Hz) Common mode noise: Min. 120dB (Min. 90dB for DC V input)
- Error of reference junction compensation: ±1.5°C (at 15-35°C)
 - ±2.0°C (at 0-50°C)
 The reference junction compensation cannot be switched off.
- Applicable standards: Thermocouple and resistance temperature detector JIS/IEC/DIN (ITS90)

Control Output

- Output: 1 point (for standard type) or 2 points (for heating/cooling type)
- Output type: Choose one from (1) to (3) below:
 - (1) Relay contact output
 - Contact capacity: 3A at 240V AC or 3A at 30V DC (with resistance load)
 - Note: The control output relay cannot be replaced by users.
 - (2) Voltage pulse output
 - On voltage: 12-18V DC
 - Off voltage: 0.1V DC or less

{
load resistance: 600Ω or greater
}

{
short-circuit current: approx. 30mA
}
 - (3) Current output
 - Output signal: 4 to 20mA
 - Maximum load resistance: 600Ω
 - Output accuracy: ±0.3% of span (at 23±2°C ambient temperature)

Alarm Functions

- **Alarm Functions (Option Code /AL or /HBA)**
- Alarm types: 22 types (waiting action can be set by software): PV high limit, PV low limit, Deviation high limit, Deviation low limit, De-energized on deviation high limit, De-energized on deviation low limit, Deviation high and low limits, High and low limits within deviation, De-energized on PV high limit, De-energized on PV low limit, Fault diagnosis output, FAIL output
- Alarm output: 2 relay contacts
 - Relay contact capacity: 1A at 240V AC or 1A at 30V DC (with resistance load)
 - Note: The alarm output relays cannot be replaced by users.

Heater Disconnection Alarm (Option Code /HBA)

The heater disconnection alarm is available when time-proportional PID control or on/off control is selected.

- Heater current setting range: 1 to 80A
- Alarm output: 1 relay contact (The terminals are the same as those of the /AL option.)
- On time of burn-out detection: Min. 0.2 second
- Sensor: CTL-6-S-H or CTL-12-S36-8 (URD Co., Ltd.)
To be purchased separately.

Timer Function (Option Code /EX/AL or /EX/HBA)

The output contact status changes when the preset time has passed since external contact (TMR) turned on.

The contact action can be selected by software from:

- (1) Make contact—the contact closes upon time-up.
 - (2) Break—the contact opens upon time-up.
- Input contact type: See **Contact Inputs** below.

Retransmission Output

The retransmission output is provided only when the /RET option is specified, but is not available for the heating/cooling type.

- Output signal: Measured value in 4-20mA DC
- Maximum load resistance: 600Ω
- Output accuracy: ±0.3% of span (at 23±2°C ambient temperature)

Contact Inputs

The contact inputs are provided only when the /EX option is specified.

- Functions: (1) Switching over two setpoints (SP1 and SP2)
 - (2) Starting a timer (See the **Alarm Functions**.)
 - (3) RUN/STOP switching
 Can be selected by parameter DIS.
- Input: 2 points (with the shared common terminal)
- Input type: Non-voltage contact or transistor contact input
- Contact capacity: At least 12V/10mA
- On/off judgment: On state for 1kΩ or less; off state for 20kΩ or greater

Communication Function

The communication function is provided only when the /RS option is specified. (For details, read the user's manual of the communications function IM 05C01E12-10E.)

Communication Protocol

- Personal computer link: Used for communication with a personal computer, or UT link module of the FA-M3 controller (from Yokogawa Electric Corporation).
- Ladder communication: Used for communication with a ladder communication module of the FA-M3, or a programmable controller of other manufacturers.
- MODBUS communication: Used for communication with equipment featuring the MODBUS protocol.

Communication Interface

- Applicable standards: Complies with EIA RS-485
- Number of controllers that can be connected: Up to 31
- Maximum communication distance: 1,200m
- Communication method: Two-wire half-duplex, start-stop synchronization, non-procedural
- Communication speed: 2400, 4800, or 9600 bps

Safety and EMC Standards

- Safety: Compliant with IEC/EN61010-1: 2001, approved by CSA1010, approved by UL508.

Installation category : CAT. II (IEC/EN61010, CSA1010) Pollution degree : 2 (IEC/EN61010, CSA1010)

Measurement category : I (CAT. I : IEC/EN61010)

Rated measurement input voltage : 10V DC max.(across terminals), 300V AC max.(across ground)

Rated transient overvoltage : 1500V (Note)

Note : It is a value on the safety standard which is assumed by IEC/EN61010-1 in measurement category I, and is not the value which guarantees an apparatus performance.

Caution: This equipment has Measurement category I, therefore do not use the equipment for measurements within measurement categories II, III and IV.

Measurement category	Description	Remarks
I CAT. I	For measurements performed on circuits not directly connected to MAINS.	
II CAT. II	For measurements performed on circuits directly connected to the low voltage installation.	Appliances, portable equipments, etc.
III CAT. III	For measurements performed in the building installation.	Distribution board, circuit breaker, etc.
IV CAT. IV	For measurements performed at the source of the low-voltage installation.	Overhead wire, cable systems, etc.

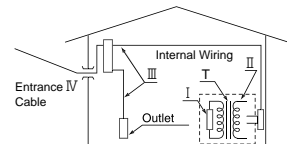

- EMC standards: Complies with EN61326.

The instrument continues to operate at a measuring accuracy of within ±20% of the range during tests.

Power Supply and Isolation

Power Supply (Common for All Models)

Power supply	Voltage	Rated at 100-240VAC ($\pm 10\%$) AC/DC 24V when "/V24" is specified.
	Frequency	50 or 60Hz
Maximum power consumption	8VA max.(4W max.) 3W max. when "/V24" is specified.	
Memory	Non-volatile memory	
Withstanding voltage	Between primary terminals and secondary terminals (See notes 1 and 2.)	1500V AC for 1 minute
Insulation resistance	Between primary terminals and secondary terminals (See notes 1 and 2.)	20M Ω or more at 500V DC

Note 1: The primary terminals are the power supply terminals and relay output terminals.
The secondary terminals are the analog input and output terminals, the voltage pulse output terminals, and the contact input terminals.

Note 2: AC/DC 24V terminals is secondary terminals.

Isolation

The bold lines below indicate reinforced isolation, and the broken line indicates functional isolation.

● Power supply terminals (100-240V AC)	● Power supply terminals AC/DC 24V (When "/V24" is specified.)
● Control output terminals (relay contacts)	● Measured value input terminals
● Alarm output terminals (2 relay contacts)	● CT input terminals for /HBA
	● 2 input terminal for /EX
	● Internal circuit
	● Control output terminals: Voltage pulse
	● RS-485 terminals for /RS

Note: Neither the measured value input terminals, CT input terminals for the /HBA option, nor input terminals for the /EX option are isolated from the internal circuit.

Construction, Mounting, and Wiring

- Construction: Dust-proof and drip-proof front panel conforming to IP65 [Model UT150] and IP55 [Models UT152 and UT155].
For side-by-side close installation the controller loses its dust-proof and drip-proof protection.
- Casing: ABS resin and polycarbonate
- Case color: Black
- Mounting: Flush panel mounting

Environmental Conditions

Normal Operating Conditions

- Warm-up time: At least 30 minutes
- Ambient temperature: 0-50°C (0-40°C when mounted side-by-side)
- Rate of change of temperature: 10°C/h or less
- Ambient humidity: 20-90% RH (no condensation allowed)
- Magnetic field: 400A/m(AT/m) or less
- Continuous vibrations of 5 to 14Hz: Amplitude of 1.2mm or less
- Continuous vibrations of 14 to 150Hz: 4.9m/s² (0.5G) or less
- Short-period vibrations: 14.7m/s² (1.5G) for 15 seconds or less
- Shock: 98m/s² (10G) for 11 milliseconds or less
- Mounting angle: Upward incline of up to 30 degrees; downward incline is not allowed.
- Altitude: 2000m or less above sea level

Maximum Effects from Operating Conditions

- (1) Temperature effects
- Thermocouple, DC mV and DC V input: $\pm 2\mu\text{V}/^\circ\text{C}$ or $\pm 0.02\%$ of F.S./ $^\circ\text{C}$, whichever is the larger
 - Resistance temperature detector: $\pm 0.05^\circ\text{C}/^\circ\text{C}$
 - Analog output: $\pm 0.05\%$ of F.S./ $^\circ\text{C}$
- (2) Effect from fluctuation of power supply voltage (within rated voltage range)
- Analog input: $\pm 0.2\mu\text{V}/\text{V}$ or $\pm 0.002\%$ of F.S./V, whichever is the larger
 - Analog output: $\pm 0.05\%$ of F.S./V

Transportation and Storage Conditions

- Temperature: -25 to 70°C
- Humidity: 5 to 95% RH (no condensation allowed)
- Shock: Package drop height 90cm (when packed in the dedicated package)

7. KEY OPERATIONS



NOTE

At power-on, the temperature controller displays the operation display ①, but if the input range setting remains OFF, then “IN” appears. In this case, press the key to display the measured input range code you want to use, then press the key to register it. (Refer to the flowchart on page 13.)

- (1) You can move between parameter setting displays using the key.
- (2) To change the set value,
 - (i) Change the display value with the or key (the period flashes).
 - (ii) Press the key to register the setting.
- (3) At the operation display ① or ②, pressing the key for at least 3 seconds retrieves the operation parameter setting display.
- (4) At the operation parameter setting display, pressing the key for at least 3 seconds transfers back to the operation display ①. Registering the key-lock parameter LOC to “-1” retrieves the setup parameter setting display.
- (5) At the setup parameter setting display, pressing the key for at least 3 seconds transfers back to the operation display ①.

Note: If you cannot change the parameter setting value, check the key-lock parameter (LOC) setting.

NOTE

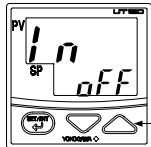

When “In” appears, press the key to display the measured input range code you want to use, then press the key to register it. After this operating, the controller shows the operating display ①.

● UT150/UT152/UT155 Measured Input Ranges

Input type	Range (°C)	Range code (°C)	Range (°F)	Range code (°F)	
	Unspecified	OFF			
Thermocouple	K	-270 to 1370°C	1	-300 to 2500°F	31
		0.0 to 600.0°C	2	32.0 to 999.9°F	32
		0.0 to 400.0°C	3	32.0 to 750.0°F	33
		-199.9 to 200.0°C	4	-300 to 400°F	34
	J	-199.9 to 999.9°C	5	-300 to 2100°F	35
	T	-199.9 to 400.0°C	6	-300 to 750°F	36
	E	-199.9 to 999.9°C	7	-300 to 1800°F	37
	R	0 to 1700°C	8	32 to 3100°F	38
	S	0 to 1700°C	9	32 to 3100°F	39
	B	0 to 1800°C	10	32 to 3200°F	40
	N	-200 to 1300°C	11	-300 to 2400°F	41
	L	-199.9 to 900.0°C	12	-300 to 1600°F	42
	U	-199.9 to 400.0°C	13	-300 to 750°F	43
	Platinel 2	0 to 1390°C	14	32 to 2500°F	44
RTD	Pt100	-199.9 to 850.0°C	15	-199.9 to 999.9°F	45
		0.0 to 400.0°C	16	32.0 to 750.0°F	46
		-199.9 to 200.0°C	17	-300 to 400°F	47
		-19.9 to 99.9°C	18	-199.9 to 999.9°F	48
JPt100	-199.9 to 500.0°C	19			
DC voltage	0 to 100mV	0.0 to 100.0	User-scalable	20	
	0 to 5V	0.000 to 5.000		21	
	1 to 5V	1.000 to 5.000		22	
	0 to 10V	0.00 to 10.00		23	

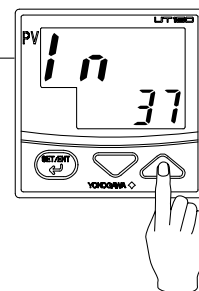

For example, to select thermocouple type E (°F), set the range code to 37.



CAUTION

To prevent electric shock, the controller should be mounted on the panel so that you do not accidentally touch the terminals when power is being applied.



NOTE

The temperature controller is shipped with the parameters set at the factory-set defaults. Check the default values against the “Parameter Lists” in the following page (P.14, 15), and change the parameter settings that need to be changed.

This section explains how to set and register parameter values.

The procedure for changing SP (target setpoint) and A1 (alarm 1 setpoint) can be found on “Changing Target Setpoint (SP)” and “Changing Alarm 1 Setpoint (A1),” respectively. You can set the other parameters in the same way.

There are no setup displays for parameters specific to functions, such as the optional alarm output functions or heating/cooling control, if they were not selected at ordering.

The setting of some parameters (such as the control mode parameter CTL) determines whether the other parameters are displayed or not.

The flowchart (P.13) will help you understand how this works.

■ Changing Target Setpoint (SP)

The following instructions assume that the controller is already receiving power.

Step 1:

Confirm that the controller shows the operating display ① during normal operation (PV and SP are displayed on the indicators).

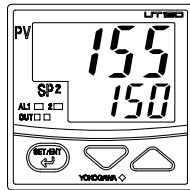

Step 2:

Press the \triangle or ∇ key to change the displayed SP value to the required value. In this example, SP is changed to 200°C.

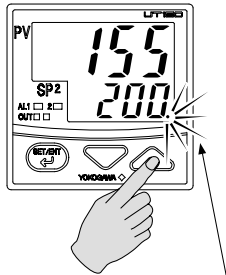

The period flashes while the value is being changed.

Step 3:

Press the SET/ENT key once to register the setting. The period goes out. SP is now changed.

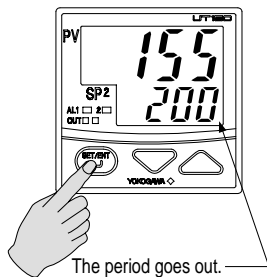

The period goes out.

■ Changing Alarm 1 Setpoint (A1)

(This setpoint appears only if the /AL or /HBA option is specified.)

Step 1:

Confirm that the controller shows the operating display ① during normal operation (PV and SP are displayed on the indicators).

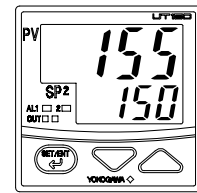

Step 2:

To enter the operating parameter setting display, press the SET/ENT key for at least 3 seconds.

If your controller has the /AL or /HBA option, the display for the Alarm 1 setpoint (A1) appears. {If not, control mode (CTL) appears.}

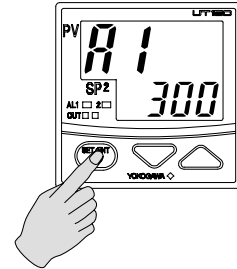

Press for at least 3 seconds.

Step 3:

Press the \triangle or ∇ key to change the current A1 value to a required value. In this example, A1 is changed to 200°C.

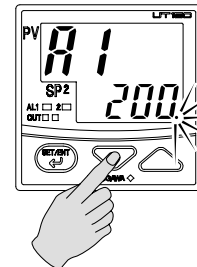

The period flashes while the value is being changed.

Step 4:

Press the SET/ENT key once to register the setting. A1 is now changed.

Another press of the SET/ENT key calls up the Alarm 2 setpoint (A2) display.

To return to the operating display ①, press the SET/ENT key for at least 3 seconds.

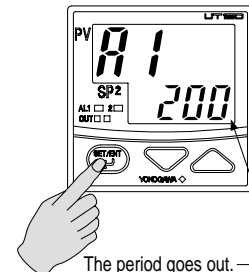

The period goes out.

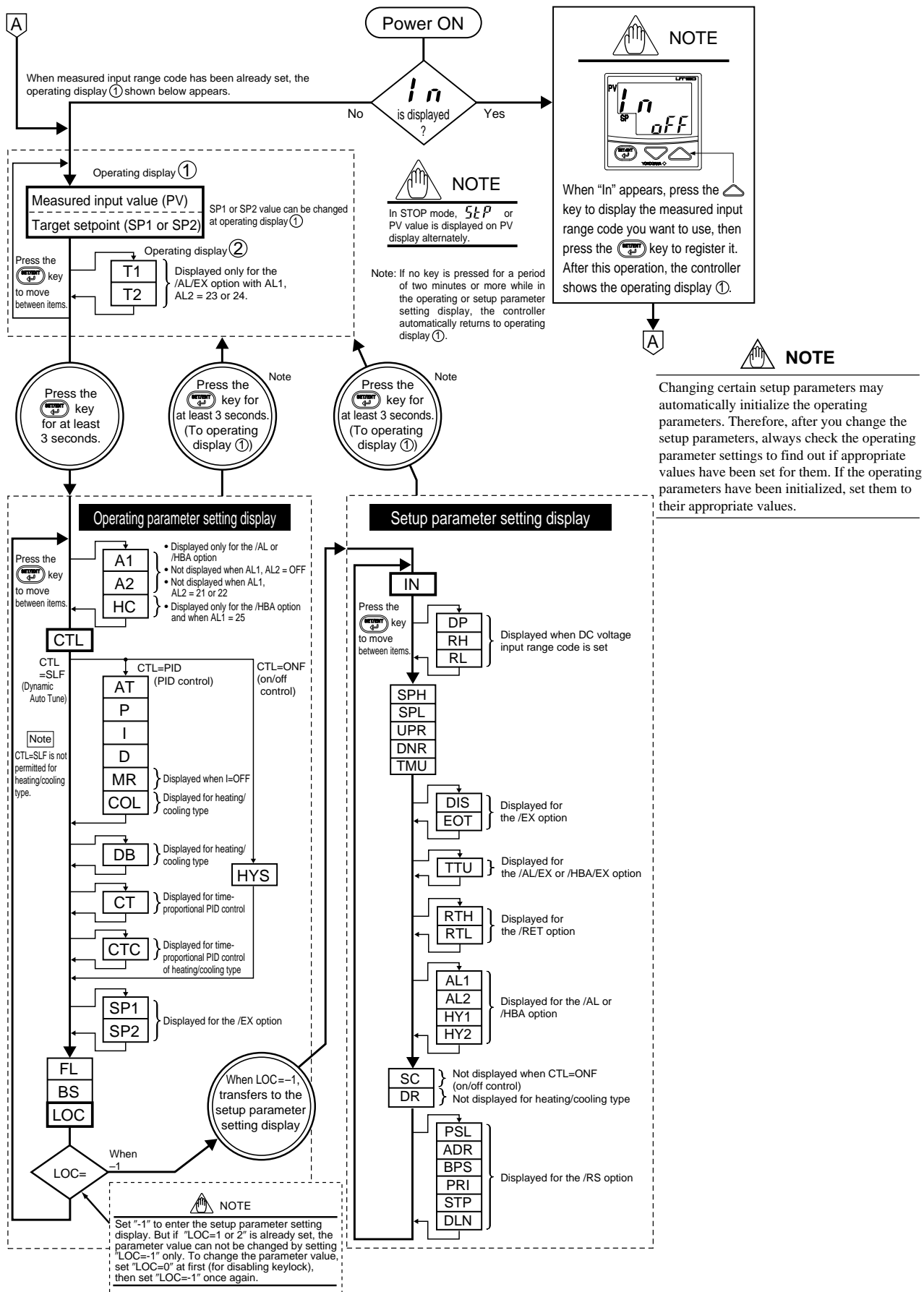

Parameter Lists

(1) Target Setpoint (SP) and Timer Setting 1 and 2

Numbers in () are the parameter setpoints that apply when the communication function is used. Ex. OFF(0), ON(1)

Code	Name	Setting range and unit	Default	User setting
(SP value display)	Target setpoint	Minimum value (SPL) to maximum value (SPH) of target setpoint range Unit: °C/°F	SPL	
T1 T1	Timer setting 1	0.0 to 99.59 Unit: minutes and seconds or hours and minutes Set the timer time unit using parameter TTU.	0.00	
T2 T2	Timer setting 2	For example, 15.25 sets 15 minutes and 25 seconds. (T1 is for AL1, and T2 is for AL2)	0.00	

(2) Operating Parameters : Parameters changed rather frequently during operation.

Code	Name	Setting range and unit	Default	User setting
A1 A1	Alarm 1 setpoint	<ul style="list-style-type: none"> ■ PV alarm Unit: °C/°F Setting range: minimum value to maximum value of measured input range (scale) ■ Deviation alarm Unit: °C/°F Setting range: -100 to 100% of the measured input range (scale) span 	Max. value of measured input range (scale) (PV alarm)	
A2 A2	Alarm 2 setpoint	<ul style="list-style-type: none"> ■ Heater disconnection alarm Unit: A (ampere) Setting range: OFF(0), 1 to 80 (can be set for the alarm 1 setpoint only) 	Min. value of measured input range (scale) (PV alarm)	
HC HC	Heater disconnection current measured value	<p>"HC" is not a parameter to be set. The current value (0 to 80) of heater disconnection detector is displayed. Unit: A (ampere)</p> <p>Settings: When the display value is ---, the heater current is not being measured.</p>		
CTL CTL	Control mode	<p>ONF(0): On/off control</p> <p>PID(1): PID control</p> <p>SLF(2): Dynamic auto tune control (cannot be set for heating/cooling control)</p>	SLF(2) :for standard type; PID(1) : for heating/cooling type	
AT AT	Auto-tuning	<p>OFF(0): Stop auto-tuning</p> <p>ON(1): Start auto-tuning</p>	OFF(0)	
P P	Proportional band	1°C/°F to the temperature that corresponds to 100% of the measured input range (scale) span	5% of measured input range (scale) span	
I I	Integral time	1 to 3600 seconds; OFF(0): no integral action	240 seconds	
D d	Derivative time	1 to 3600 seconds; OFF(0): no derivative action	60 seconds	
MR MR	Manual reset	-100 to 100%	50.0% for standard type; 0.0% for heating/cooling type	
COL COL	Cooling-side gain	0.01 to 9.99 times	1.00 times	
DB db	Deadband	<ul style="list-style-type: none"> ■ PID control Unit: °C/°F Setting range: -(proportional band setting) to +(proportional band setting) ■ On/off control Unit: °C/°F Setting range: -50 to +50% of measured input range (scale)span 	0% of measured input range (scale) span	
HYS HYS	Hysteresis for on/off control	0°C/°F to the temperature that corresponds to 100% of the measured input range (scale) span	0.5% of measured input range (scale) span	
CT CT	Control output cycle time	1 to 240 seconds	30 seconds	
CTC CTC	Cooling-side control output cycle time	1 to 240 seconds	30 seconds	
SP1 SP1	Target setpoint 1	Minimum value (SPL) to maximum value (SPH) of target setpoint range Unit: °C/°F	SPL	
SP2 SP2	Target setpoint 2	There are also optional engineering units for voltage input.	SPL	
FL FL	PV input filter	OFF(0), 1 to 120 seconds	OFF(0)	
BS BS	PV input bias	-100 to 100% of measured input range (scale) span	0% of measured input range (scale) span	
LOC LOC	Key lock	<p>0: No key lock</p> <p>1: Prevents operations from being changed except for the changing of SP in the operating display</p> <p>2: Prevents all parameter changing operations</p> <p>-1: Set "-1" to enter the setup parameter setting display. But if "LOC=1 or 2" is already set, the parameter value can not be changed by setting "LOC=-1" only. To change the parameter value, set "LOC=0" at first (for disabling keylock), then set "LOC=-1" once again.</p>	0	

(3) Setup Parameters : Parameters rarely changed in normal use after once having been set.

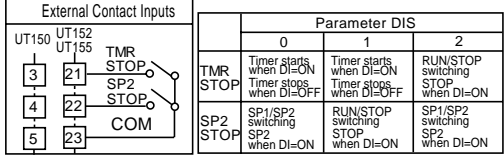
Code	Name	Setting range and unit	Default	User setting
IN	<i>ln</i>	Measured input type 1 to 23, 31 to 48 (See input range code list.) OFF(0): No input (If no input type is specified at the time of ordering, you must set the input type.)	OFF(0), or the input range code specified with order	
DP	<i>dP</i>	Decimal point position of measured input 0: No decimal place (nnnn) (Displayed at voltage input) 1: One decimal place (nn.n) 2: Two decimal places (nn.nn) 3: Three decimal places (n.nnn)	1	
RH	<i>rH</i>	Maximum value of measured input scale (RL + 1) to 9999 (Displayed at voltage input)	100.0	
RL	<i>rL</i>	Minimum value of measured input scale -1999 to (RH -1) (Displayed at voltage input)	0.0	
SPH	<i>SPH</i>	Maximum value of target setpoint range (SPL+1°C) to the maximum value of the measured input range (scale) ; Unit: °C/°F	Maximum value of measured input range (scale)	
SPL	<i>SPL</i>	Minimum value of target setpoint range Minimum value of measured input range (scale) to (SPH -1°C) Unit: °C/°F	Minimum value of measured input range (scale)	
UPR	<i>UPr</i>	Setpoint ramp-up-rate OFF(0) or a value from the minimum to the maximum value of the measured input range (scale)	OFF(0)	
DNR	<i>dnr</i>	Setpoint ramp-down-rate Unit: °C/min or °C/hour, °F/min or °F/hour Set the ramp-rate time unit using parameter TMU.	OFF(0)	
TMU	<i>tNu</i>	Setpoint ramp-rate time unit 0 : °C or °F / hour 1 : °C or °F / min	1	
DIS	<i>diS</i>	DI-function selection 	0	
EOT	<i>Eot</i>	Output in STOP mode In STOP mode by contact input, fixed control output can be generated. 0 : 0%, 1 : 100%	0	
TTU	<i>tTu</i>	Timer time unit 0 : hour.minute 1 : minute.second	1	
RTH	<i>rTH</i>	Maximum value of retransmission output Temperature input : Within measured input range Voltage input : RTL+1digit to max. value of measured input (scale)(RH)	Maximum value of measured input range (scale)	
RTL	<i>rTL</i>	Minimum value of retransmission output Min. value of measured input (scale)(RL) to RTH-1digit However, RTL<RTH	Minimum value of measured input range (scale)	
AL1	<i>AL1</i>	Alarm 1 type OFF(0) or a value from 1 to 22 (see the table of alarm function list), and either 23 or 24 (if the timer function [/EX option] is included), and 25 (if the heater disconnection function [/HBA option] is included)	1 (PV high limit alarm)	
AL2	<i>AL2</i>	Alarm 2 type OFF(0) or a value from 1 to 22 (see the table of alarm function list), and either 23 or 24 (if the timer function [/EX option]) is included)	2 (PV low limit alarm)	
HY1	<i>HY1</i>	Alarm 1 hysteresis 0 to 100% of measured input range (scale) span Unit: °C/°F	0.5% of measured input range (scale) span	
HY2	<i>HY2</i>	Alarm 2 hysteresis		
SC	<i>Sc</i>	SUPER function ON(1): Uses the SUPER function OFF(0): Does not use SUPER function Note: Not displayed when on/off control	OFF(0)	
DR	<i>dr</i>	Direct/reverse action 0: Reverse action 1: Direct action Note: Not displayed for heating/cooling type	0	
PSL	<i>PSL</i>	Protocol selection 0: PC-link communication 1: PC-link communication with sum check 2: Ladder communication 3: MODBUS in ASCII mode 4: MODBUS in RTU mode	0	
ADR	<i>Adr</i>	Controller address 1 to 99 However, the number of controllers that can be connected per host device is 31 at the maximum.	1	
BPS	<i>bPS</i>	Baud rate 2.4(0): 2400 bps 4.8(1): 4800 bps 9.6(2): 9600 bps	9.6(2)	
PRI	<i>Pr1</i>	Parity NON(0): Disabled EVN(1): Even parity ODD(2): Odd parity	EVN(1)	
STP	<i>StP</i>	Stop bit 1 or 2 bits	1 bit	
DLN	<i>dLn</i>	Data length 7 or 8 bits • 8 bits when ladder, MODBUS (RTU) • 7 bits when MODBUS (ASCII)	8 bits	

Alarm Function List

Alarm type	Action (“Opn” and “Cls” indicate that the relay contact is opened and closed; “on” and “off” indicate that the lamp is on and off; and white triangles indicate temperature control setpoints.)	Alarm type code		Alarm type	Action (“Opn” and “Cls” indicate that the relay contact is opened and closed; “on” and “off” indicate that the lamp is on and off; and white triangles indicate temperature control setpoints.)	Alarm type code	
		Closed contact during alarm	Open contact during alarm			Closed contact during alarm	Open contact during alarm
No alarm		OFF					
PV high limit		1 11 (See note.)		De-energized on deviation low limit			6 16 (See note.)
PV low limit		2 12 (See note.)		Deviation high and low limit		7 17 (See note.)	
Deviation high limit		3 13 (See note.)		Deviation within-high-and-low-limit		8 18 (See note.)	
Deviation low limit		4 14 (See note.)		De-energized on PV high limit			9 19 (See note.)
De-energized on deviation high limit		5 15 (See note.)		De-energized on PV low limit			10 20 (See note.)
Fault diagnosis output	The contact is closed at input burnout.	21		Break timer function		24	
FAIL output	The output contact is opened in the following events: <ul style="list-style-type: none"> • Program error • ROM error • RAM error • power failure • A/D converter error • RJC error • EEPROM error 	22					
Timer function		23		Heater disconnection alarm		25	

Note: The alarms numbered 1 to 10 have no waiting action, while alarms 11 to 20 have a waiting action.

The waiting action turns off the PV and deviation alarms that occur from the start of the control operation until a stable state is reached.

Waiting action

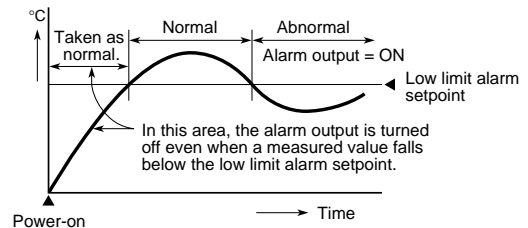

■ Description of Parameters

This section describes the parameter functions specific to the UT150/UT152/UT155 temperature controllers. (The functions described in other sections of this manual and the general functions are not discussed.)

Parameter	Function	Parameter	Function
CTL	<p>Control mode</p> <p>Select one from the following:</p> <ul style="list-style-type: none"> a. Dynamic auto tune control (SLF) (See note) b. PID control (PID) c. On/off control (ONF) <p>Note: Dynamic auto tune control is not available for heating/cooling control.</p> <p>Read the section below this table to find out more about dynamic auto tune control.</p>	BS	<p>PV input bias</p> <p>This function adds a bias value to the measured input value, and the result is used for display and control computation.</p> $\boxed{\text{PV value inside the controller}} = \boxed{\text{measured input value}} + \boxed{\text{PV bias}}$ <p>This function is useful for carrying out fine adjustment when the PV value is within the required accuracy but it differs from the value obtained by other equipment.</p>
MR	<p>Manual reset</p> <p>You can set this parameter only for control without an integral action (when registered as CTL=PID and I=OFF). The controller outputs the manual reset (MR) value when PV=SP. For example, if you set MR=50%, the controller outputs (OUT) 50% when PV=SP.</p>	DP	<p>Decimal point of measurement input</p> <p>For DC voltage input, the input signal can be scaled for the particular engineering unit. For example, if you set the input type (IN) at range code 22, the initial range is 0.0 to 100.0.</p> <ul style="list-style-type: none"> a. Using DP, set the decimal point position fit for the engineering unit you want to use. (In the example below, the 2 digits to the right of the decimal point) b. Next, register the scale values of the measured input scale using RH and RL. (In the example below, RH=10.00 and RL=0.00)
COL	<p>Cooling-side gain</p> <p>For heating/cooling control, you can set the ratio between the cooling-side output and heating-side output.</p> <p>For example, if you set COL=2.0 and the heating-side output is 10% at a certain deviation (SP-PV), then the cooling-side output will be 20% when the cooling-side also reaches that deviation.</p>	RH, RL	<p>Maximum/minimum value of measured input scale</p>
DB	<p>Deadband</p> <p>You can only set a deadband for heating/cooling control. In a positive deadband, there are neither heating-side nor cooling-side outputs. In a negative deadband, there are both heating-side and cooling-side outputs, which overlap each other.</p> <ol style="list-style-type: none"> 1. When the deadband of a heating/cooling type is positive (Proportional band [P] control) 2. When both the heating and cooling sides are under on-off control 	SPH, SPL	<p>Maximum/minimum value of target setpoint range</p> <p>Using the SPH and SPL parameters, you can limit the setting range of the target setpoint (SP) within the measured input range(scale).</p> <p>This function prevents SP from being mistakenly set at too large or too small a value (beyond the setting range).</p>
HYS	<p>Hysteresis for on/off control</p> <p>For on/off control (CTL=ONF), you can set a hysteresis around the on/off point (SP) to prevent chattering.</p>	UPR, DNR	<p>Setpoint ramp up/ramp-down rate</p> <p>To prevent a sudden change in SP, or to change SP at a constant rate, ramp-up and ramp-down rates can be set separately. This function operates at the following events.</p> <ul style="list-style-type: none"> a. SP change b. SP1/SP2 switching c. Power-on <p>At power-on, SP starts from the current PV value.</p> <p>Set the ramp-rate time unit using parameter TMU.</p>
CT CTC	<p>Control output / cooling-side control output cycle time</p> <p>The cycle time is the period of on/off repetitions of a relay or voltage pulse output in time proportional PID control. The ratio of the ON time to the cycle time is proportional to the control output value.</p>	HY1, HY2	<p>Hysteresis for alarm 1 and 2</p> <p>The alarms are output as relay outputs. Since a relay has a limited life, excessive on/off actions will shorten the life of the alarm. To prevent this, you can set a hysteresis to prevent excessive on/off actions for both alarm 1 and alarm 2.</p>
FL	<p>PV input filter</p> <p>This function should be used when the PV display value may fluctuate greatly, for example, when the measured input signal contains noise. The filter is of the first-order lag type, and FL sets the time constant. If a larger time constant is set, the filter can remove more noise.</p>	SC	<p>SUPER function selection</p> <p>The SUPER function is effective in the following cases:</p> <ul style="list-style-type: none"> a. An overshoot must be suppressed. b. The rise-up time needs to be shortened. c. The load often varies. d. SP is changed frequently. <p>Note 1: The SUPER function will not work when on/off control is selected, or I or D constants is set at OFF in PID control.</p> <p>Note 2: For some types of systems, the SUPER function may not be so useful. If this is the case, turn off the function.</p>

■ What is Dynamic Auto Tune Control?

Dynamic auto tune control is one of the features offered by the temperature controller.

When the controller is turned on or the process variable (PV) starts “hunting”, this mode of control monitors the behavior of the PV and/or OUT (control output value) to automatically determine the optimum PID constants. This means that the PID constants may be changed automatically. If this is not desirable for your system, operate the controller in the normal “PID control”.

If you want to automatically determine the PID constants at the initial startup of the controller, first define the target setpoint variable (SP) and then turn the controller off once and then back on again. Do not use dynamic auto tune control for a system where there is interference or continual disturbances.



IMPORTANT

To use dynamic auto tune control,

- (1) be sure to turn on the final control element, such as a heater, before starting the control, and
- (2) make sure the controlled loop is a closed loop.

If you do not follow these precautions, improper PID constants may be written into the controller. If this occurs, carry out the following:

- Set the parameter CTL at PID.
- Set the PID constants at the factory-set defaults ($P = (\text{upper range-limit} - \text{lower range-limit}) \times 5\%$; $I = 240 \text{ sec.}$; and $D = 60 \text{ sec.}$)
- Set the parameter CTL at SLF.

If the control still doesn't work properly, stop using the dynamic auto tune control function. Change the parameter CTL setting to PID and execute auto-tuning to obtain the PID constants.

8. TROUBLESHOOTING

In the event of an abnormality, perform the following checks as outlined by the flowchart.

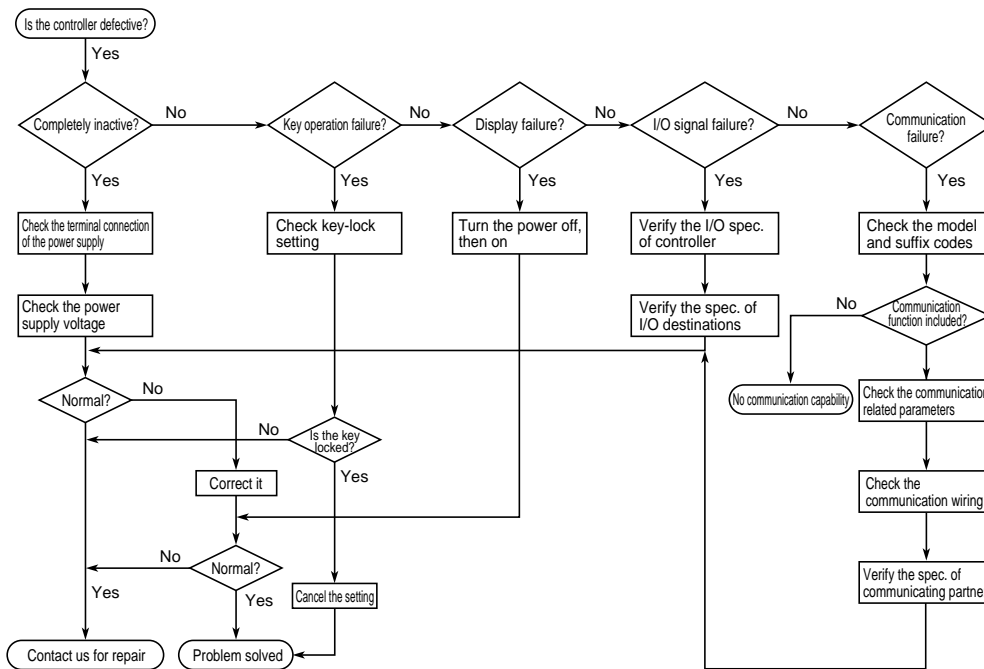

■ Error Display during Operation

(1) If the controller displays one of the following, carry out the appropriate remedy for the particular error.

Display	Error content	Remedy
<i>P.Er</i> P.Er	The parameter is abnormal	Check the settings of all the parameters and set them at their proper values.
<i>b.o</i> B.o	Input burnout	Check the sensor wiring and correct it.
<i>ooo</i> OOO	PV over-scale (PV exceeds its effective range.)	Check the input type and range settings and correct them.
<i>uuu</i> UUU	PV under-scale (PV falls below its effective range.)	
Flashing period on PV display	Communication failure (for /RS option only)	Press any key to stop the flashing.

(2) The controller needs to be repaired if any of the indications in the table below appear.

In these cases, do not try to repair the controller yourself. Order a new controller or contact us for repair.

Display	Error content	Display	Error content
Unknown (at power-on)	CPU failure	Flashing "Err" (at power-on)	RAM or ROM failure
All extinguished (at power-on)	Power source failure	Flashing "Err" (during operation)	A/D converter failure, RJC failure, or EEPROM failure
"Err" (at power-on)	Calibration abnormal		

■ When Power Failure Occurred during Operation

- Momentary power failures of less than 20ms (or less than 1ms when "/V24" is specified) have no effect on the controller operation (i.e., normal operation continues).
- For power failures longer than 20ms (or longer than 1ms when "/V24" is specified), however the status will be as follows.

(The controller action at power recovery is the same as at power-on.)

- Alarm action: Continues (but alarms with a waiting action enter the waiting state once)
- Setting parameters : Maintained
- Auto-tuning: Canceled

YOKOGAWA

Yokogawa Electric Corporation

YOKOGAWA ELECTRIC CORPORATION

Network Solutions Business Division

2-9-32, Nakacho, Musashino-shi, Tokyo, 180-8750 JAPAN

Phone: +81-422-52-7179 Facsimile: +81-422-52-6793

Sales Branch Offices

Tokyo, Nagoya, Osaka, Hiroshima, Fukuoka

YOKOGAWA CORPORATION OF AMERICA

Headquarters

2 Dart Road, Newnan, GA. 30265-1094 U.S.A.

Phone: +1-770-253-7000 Facsimile: +1-770-251-0928

Sales Branch Offices / Texas, Chicago, Detroit, San Jose

YOKOGAWA EUROPE B. V.

Headquarters

Databankweg 20, 3821 AL Amersfoort THE NETHERLANDS

Phone: +31-334-64-1611 Facsimile: +31-334-64-1610

Sales Branch Offices / Houten (The Netherlands), Wien (Austria), Zaventem (Belgium), Ratingen (Germany), Madrid (Spain), Bratislava (Slovakia), Runcorn (United Kingdom), Milano (Italy), Vélizy villacoublay(France), Johannesburg(Republic of South Africa)

YOKOGAWA AMERICA DO SUL S.A.

Headquarters & Plant

Praca Acapulco, 31-Santo Amaro, Sao Paulo/SP, BRAZIL CEP-04675-190

Phone: +55-11-5681-2400 Facsimile: +55-11-5681-4434

YOKOGAWA ENGINEERING ASIA PTE. LTD.

Head office

5 Bedok South Road, Singapore 469270 SINGAPORE

Phone: +65-6241-9933 Facsimile: +65-6241-2606

YOKOGAWA ELECTRIC KOREA CO., LTD.

Seoul Sales office

395-70, Shindaebang-dong, Dongjak-gu, Seoul,156-010, KOREA

Phone: +82-2-3284-3000 Facsimile: +82-2-3284-3019

YOKOGAWA TAIWAN CORPORATION

Head office

17F, No.39, Sec. 1, Chung Hwa Road Taipei, 100 TAIWAN

Phone: +886-2-2314-9166 Facsimile: +886-2-2314-9918

YOKOGAWA AUSTRALIA PTY. LTD.

Head office

CentreCourt D1, 25-27 Paul Street North, North Ryde, N. S. W. 2113, AUSTRALIA

Phone: +61-2-9805-0699 Facsimile: +61-2-9888-1844

YOKOGAWA INDIA LTD.

Head office

40/4 Lavelle Road, Bangalore, 560 001, INDIA

Phone: +91-80-227-1513 Facsimile: +91-80-227-4270

LTD. YOKOGAWA ELECTRIC

Grokholskiy per. 13, Build. 2, 4th Floor, 129010, Moscow, RUSSIA FEDERATION

Phone: +7-095-737-7868 Facsimile: +7-095-737-7869
