

# General Specifications

## Digital I/O Modules (for ProSafe-RS)



### GS 32Q06K40-31E

[Release 3]

#### ■ GENERAL

This GS provides the hardware specifications of the digital I/O modules that can be installed in the Safety Node Unit (SNB10D) and Safety Control Units (SSC60□, SSC50□, SSC10□).

#### ■ STANDARD SPECIFICATIONS

##### ● Input Module

Input modules accept contact signals from the field. SDV144 can be made dual-redundant.

Item	Specifications
Model	SDV144
Number of inputs	16-channel, module isolation (*3)
Input signal	No-voltage contact ON: 1 kΩ maximum OFF: 100 kΩ minimum
Input current	6 mA ± 20 % (External power supply, 24 V DC at 0 Ω input)
Contact rating	24 V DC +20 % / -10 % (*1), 10 mA or greater
External power supply	24 V DC +20 % / -10 % (*1) (*3) Current capacity: 200 mA
Instantaneous maximum permissible input voltage	30.0 V DC
Input response time	40 ms maximum
Withstand voltage	2 kV AC between input signal and system, 16-input line collectively connected (*2)
Current consumption	290 mA maximum (5 V DC) 140 mA maximum (24 V DC)
Weight	0.36 kg (For pressure clamp terminal block or MIL cable) 0.41 kg (With signal cable interface adapter)
External connection	Pressure clamp terminal MIL cable Dedicated signal cable (AKB331)

\*1: The contact rating and the external power supply of SDV144 style code S1, S2 and S3 are 24 V DC ± 5 %.

\*2: When connecting SDV144 and SED4D terminal board using the dedicated signal cable, the withstand voltage is 500 V AC (between input signal lines and system). If MIL connector cables are used, the withstand voltage depends on their cable's electrical specifications.

\*3: Number of input channels which a user can use and external power supply are restricted in case of SDV144-S□C. Refer to "ProSafe-RS Outline of I/O Modules (GS 32Q06K20-31E)".

If SDV144 field wiring diagnostic functions are used, the following diagnostic elements should be installed for individual channels in the vicinity of the field equipment:

- SCB100 (for defective open circuit detection while accepting off signals) (\*1)
- SCB110 (for defective short-circuit detection while accepting on signals) (\*2)

\*1: Input signals are normally off while in normal operation.  
 \*2: Input signals are normally on while in normal operation.

When the input signals are normally off while in normal operation, connect the SCB100 in parallel with the contact output of the field equipment as given below.

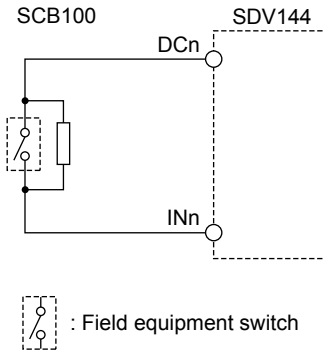

F01E.ai

When the input signals are normally on while in normal operation, connect the SCB110 in series with the contact output of the field equipment (take care about the polarity taking note of the polarity).

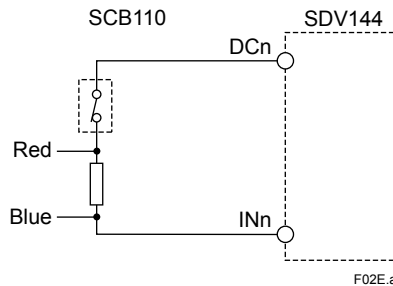

F02E.ai

When checking for both defective short and open circuits, connect the SCB100 and SCB110 in parallel and series with the contact outputs of the field equipment respectively, as given below.

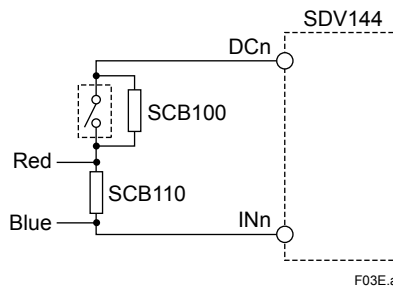

F03E.ai

## ● Output Module

Output modules output on/off status signals to field equipment.

The output modules can be made dual-redundant respectively. They incorporate field wiring diagnostic functions, so they require no wiring diagnosis elements.

Item	Specifications
<b>Model</b>	SDV531
<b>Number of outputs</b>	8-channel, module isolation (*6)
<b>Output voltage</b>	24 V DC
<b>Output voltage drop</b>	1 V maximum
<b>External power supply rating</b>	24 V DC, 5 A minimum
<b>External power supply</b>	24 V DC +20 %/-10 % (*1) Current capacity: 5 A
<b>Maximum leak current at output off status</b>	1.6 mA
<b>Output format</b>	Current source
<b>Maximum load current</b>	0.6 A/output line (4.8 A in total output lines) (*2) (*6)
<b>Minimum load current</b>	35 mA
<b>Load resistance range</b>	40 to 685 Ω (*3)
<b>Output response time</b>	30 ms maximum
<b>Withstand voltage</b>	2 kV AC (between output signal lines and system), 8-point input lines collectively connected (negative lines) (*4)
<b>Current consumption</b>	280 mA maximum (5 V DC) 140 mA maximum (24 V DC)
<b>Weight</b>	0.28 kg (For pressure clamp terminal block or MIL cable) 0.34 kg (With dedicated signal cable interface adapter)
<b>External connection</b>	Pressure clamp terminal MIL cable Dedicated signal cable (AKB331, AKB651 (*5))

\*1: External power supply of SDV531-S style code S1 and S2 is 24 V DC ± 5%.

\*2: Do not exceed this value, including the case of inrush/variation of the load current.

\*3: Resistance value of the load for both ON and OFF state, including the field wiring resistance.

\*4: When connecting SDV531 and SED4D terminal board using AKB331 dedicated signal cable, the withstand voltage is 500 V AC (between output signal lines and system). If MIL connector cables are used, the withstand voltage depends on their cable's electrical specifications.

\*5: AKB651 can be used for connection with SDV531-L only.

\*6: Number of output channels which a user can use and maximum load current are restricted in case of SDV531-L□C. Refer to "ProSafe-RS Outline of I/O Modules (GS 32Q06K20-31E)".

Item	Specifications
<b>Model</b>	SDV541
<b>Number of outputs</b>	16-channel, module isolation (*5)
<b>Output voltage</b>	24 V DC
<b>Output voltage drop</b>	1 V maximum
<b>External power supply rating</b>	24 V DC, 3.4 A minimum
<b>External power supply</b>	24 V DC + 20 % / -10 % (*1) Current capacity: 3.4 A
<b>Maximum leak current at output off status</b>	1.6 mA
<b>Output format</b>	Current source
<b>Maximum load current</b>	0.2 A/output line (3.2 A in total output line) (*2) (*5)
<b>Minimum load current</b>	35 mA
<b>Load resistance range</b>	120 to 685 $\Omega$ (*3)
<b>Output response time</b>	30 ms maximum
<b>Withstand voltage</b>	2 kV AC (between output signal lines and system), 16-point input lines collectively connected (negative lines) (*4)
<b>Current consumption</b>	300 mA maximum (5 V DC) 150 mA maximum (24 V DC)
<b>Weight</b>	0.29 kg (For pressure clamp terminal block or MIL cable) 0.31 kg (With dedicated signal cable interface adapter)
<b>External connection</b>	Pressure clamp terminal MIL cable Dedicated signal cable (AKB331, AKB651)

- \*1: External power supply of SDV541 style code S1 is 24 V DC  $\pm$  5%.
- \*2: Do not exceed this value, including the case of inrush/variation of the load current.
- \*3: Resistance value of the load for both ON and OFF state, including the field wiring resistance.
- \*4: When connecting SDV541 and SED4D terminal board using AKB331 dedicated signal cable, the withstand voltage is 500 V AC (between output signal lines and system). If MIL connector cables are used, the withstand voltage depends on their cable's electrical specifications.
- \*5: Number of output channels which a user can use and maximum load current are restricted in case of SDV541-S□C. Refer to "ProSafe-RS Outline of I/O Modules (GS 32Q06K20-31E)".

Item	Specifications
<b>Model</b>	SDV521
<b>Number of outputs</b>	4-channel, module isolation (*4)
<b>Output voltage</b>	24 V DC
<b>Output voltage drop</b>	1 V maximum
<b>External power supply rating</b>	24 V DC, 10 A minimum
<b>External power supply</b>	24 V DC +20 %/-10 % Current capacity: 8.2 A (*1)
<b>Maximum leak current at output off status</b>	1.6 mA
<b>Output format</b>	Current source
<b>Maximum load current</b>	2 A/output line (8 A in total output lines) (*2) (*4)
<b>Minimum load current</b>	100 mA
<b>Load resistance range</b>	12 to 240 $\Omega$ (*3)
<b>Output response time</b>	30 ms maximum
<b>Withstand voltage</b>	2 kV AC (between output signal lines and system), 4-point input lines collectively connected (negative lines)
<b>Current consumption</b>	280 mA maximum (5 V DC) 140 mA maximum (24 V DC)
<b>Weight</b>	0.36 kg
<b>External connection</b>	Dedicated signal cable (AKB651)

- \*1: Required capacity when all the channels are loaded with rated load. Please use external source with the capacity most appropriate for load to be applied.  
(When it is probable to get inrush load, use power source with the inrush current added.)
- \*2: 1 A for filament lamp under the specified conditions. When rush current is over 10 A, the module cannot be connected.
- \*3: Resistance value of the load for both ON and OFF state, including the field wiring resistance.
- \*4: Number of output channels which a user can use and maximum load current are restricted in case of SDV521-S□C. Refer to "ProSafe-RS Outline of I/O Modules (GS 32Q06K20-31E)".

Item	Specifications
<b>Model</b>	SDV526 (*1)
<b>Number of outputs</b>	4-channel, module isolation
<b>Output voltage</b>	100 to 120 V AC
<b>Output voltage drop</b>	1.3 V AC + 0.01 V AC/m minimum 2.5 V AC + 0.04 V AC/m maximum (*2)
<b>External power supply rating</b>	100 to 120 V AC (*5)
<b>External power supply</b>	100 to 120 V AC +10 %/-15 %
<b>Maximum leak current at output off status</b>	2 mA
<b>Output format</b>	Current source (common N side)
<b>Maximum load current</b>	0.5 A/output line
<b>Minimum load current</b>	0.1 A/output line
<b>Load resistance range</b>	5 k $\Omega$ (*3)
<b>Output response time</b>	60 ms
<b>Withstand voltage</b>	1500 V AC (between output signal lines and system)
<b>Current consumption</b>	500 mA maximum (5 V DC) 50 mA maximum (24 V DC)
<b>Weight</b>	0.36 kg
<b>External connection</b>	Dedicated signal cable (AKB652) (*4)

- \*1: SDV526 is not capable to of detecting the following faults.  
- short circuit between channels  
- output short circuit while output signals are off  
Set minimum output holding time to one second. Acceptable reverse electromotive voltage for output channel is 450 V, 1 ms (The reverse electromotive voltage is caused by the connection with inductive load such as relays or solenoid valves.)  
Supported by R2.02.00 or later.
- \*2: It depends on the length of AKB652.
- \*3: Resistance value of the load for OFF state, including the field wiring resistance.
- \*4: For dual-redundant configuration, two AKB652 cables with the same length should be used.
- \*5: In order to comply with the CE Marking Low Voltage Directive, SDV526 has to limit its connection to the external power supply terminal only with the secondary circuit. Reinforced insulation is required by EN 61010-1:2010 using an isolation transformer or alike. This means that 100-120V AC isolated from main power supply has to connect with SDV526.

Item	Specifications
<b>Model</b>	SDV53A (*1)
<b>Number of outputs</b>	8-channel, module isolation
<b>Output voltage</b>	48 V DC
<b>Output voltage drop</b>	1 V maximum
<b>External power supply rating</b>	48 V DC, 5 A minimum
<b>External power supply</b>	48 V DC +20 %/-10 % Current capacity: 5 A (*2)
<b>Maximum leak current at output off status</b>	3.2 mA
<b>Output format</b>	Current source
<b>Maximum load current</b>	0.6 A/output line (4.8 A in total output lines) (*3)
<b>Minimum load current</b>	100 mA
<b>Load resistance range</b>	80 to 480 $\Omega$ (*4)
<b>Output response time</b>	36 ms maximum
<b>Withstand voltage</b>	2 kV AC (between output signal lines and system), 8-point input lines collectively connected (negative lines)
<b>Current consumption</b>	290 mA maximum (5 V DC) 150 mA maximum (24 V DC)
<b>Weight</b>	0.46 kg
<b>External connection</b>	Dedicated signal cable (AKB331 (*5), AKB651)

- \*1: R2.03 or later
- \*2: Required capacity when all the channels are loaded with rated load. Please use external source with the capacity most appropriate for load to be applied.  
(When it is probable to get inrush load, use power source with the inrush current added.)
- \*3: 0.3 A for filament lamp under the specified conditions. When rush current is over 3 A, the module cannot be connected.
- \*4: Resistance value of the load for both ON and OFF state, including the field wiring resistance.
- \*5: Use AKB331 style code S3.

## EXTERNAL DIMENSIONS

### ● SDV144 Digital Input Module

For pressure clamp and MIL cable

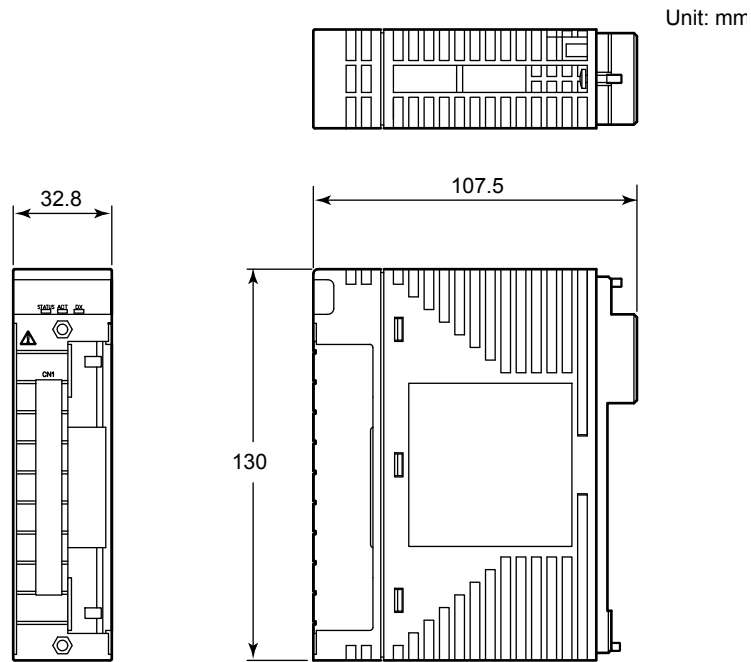

F04E.ai

### With signal cable interface adapter

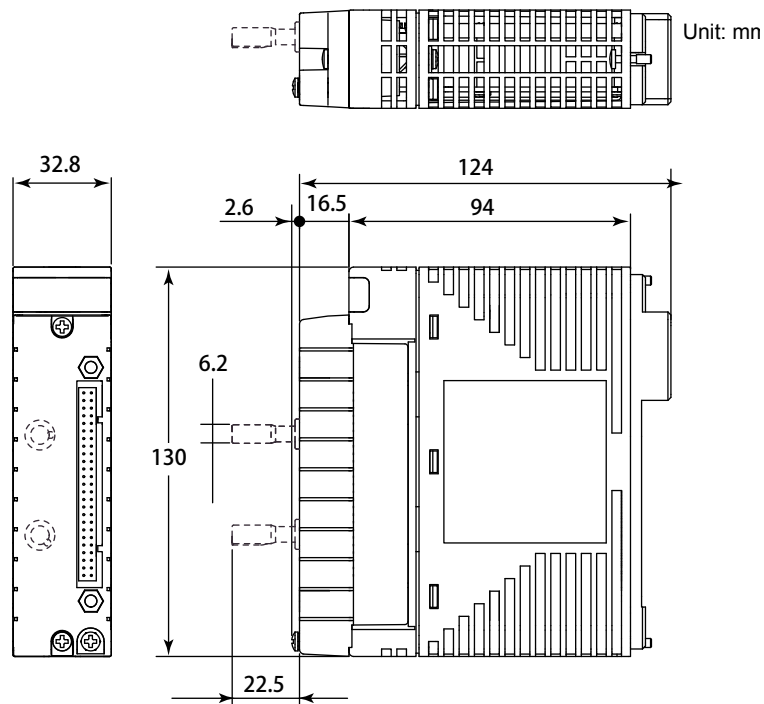

Note: Dash line expresses prevention pin of false insertion.  
This pin is added if option code /PRP is specified

F07E.a

● SDV531 and SDV541 Digital Output Module

For pressure clamp and MIL cable

Unit: mm

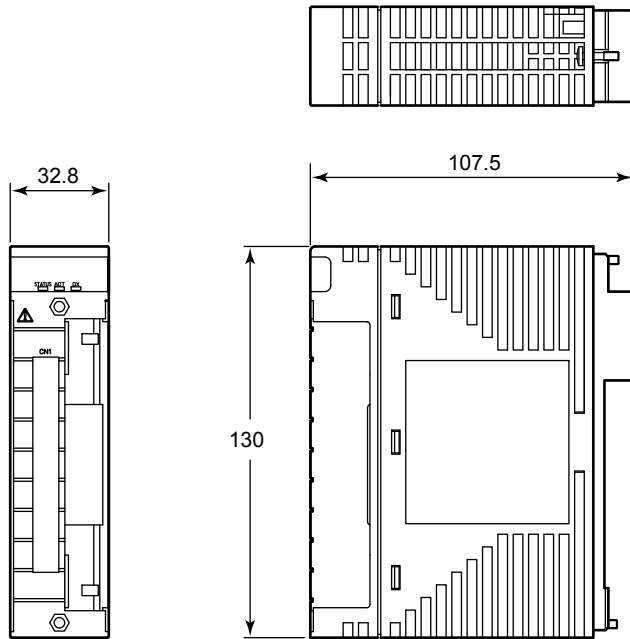

F05E.ai

With signal cable interface adapter

Unit: mm

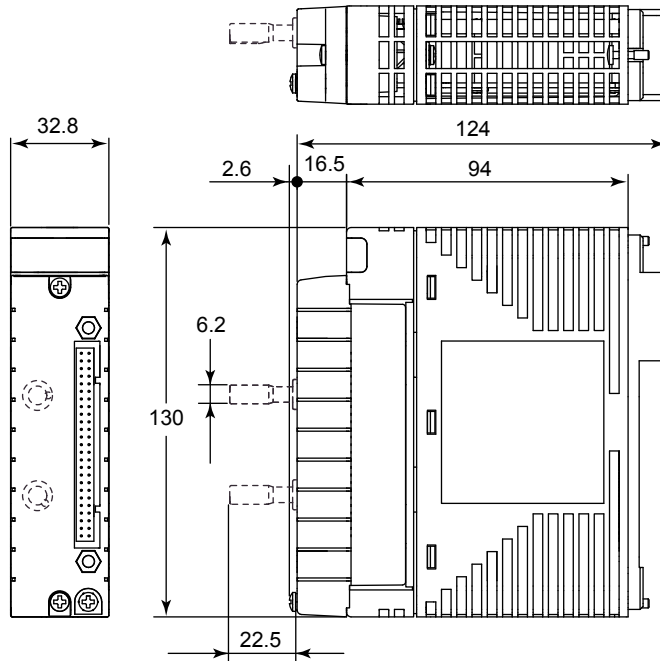

Note: Dash line expresses prevention pin of false insertion.  
This pin is added if option code /PRP is specified

F08E.ai

● SDV521 Digital Output Module

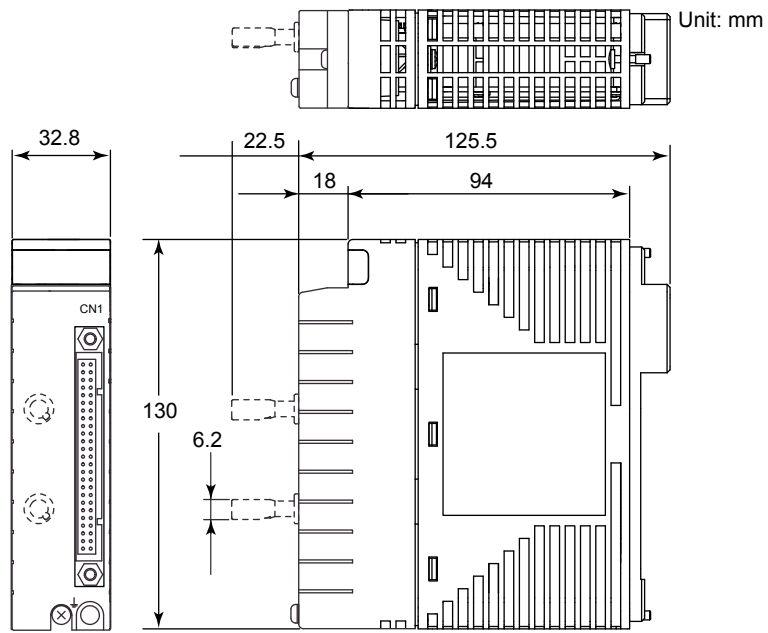

Note: Dash line expresses prevention pin of false insertion.

F09E.ai

● SDV526 Digital Output Module

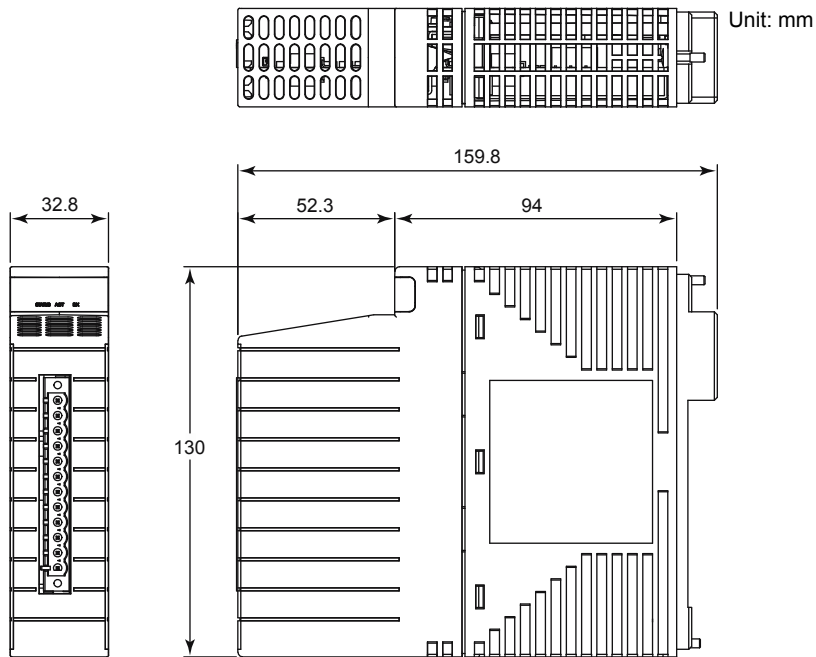

F10E.ai



● SDV53A Digital Output Module

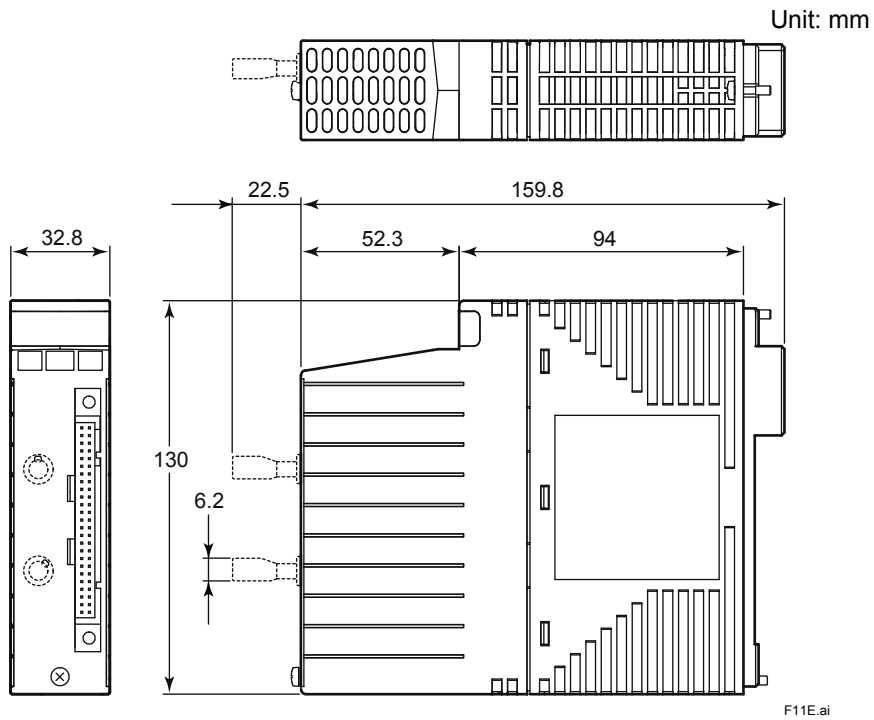

● SCB100 and SCB110 Wiring Diagnosis Elements

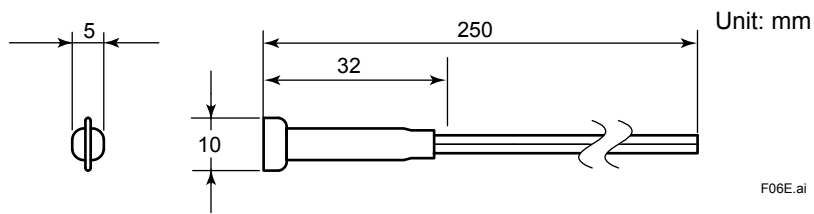

## ■ MODEL AND SUFFIX CODES

### Digital Input Module

		Description
<b>Model</b>	SDV144	Digital Input Module (16-channel, 24 V DC, module isolation)
<b>Suffix Codes</b>	-S	Standard type
	5	For pressure clamp terminal block or MIL cable with no explosion protection
	6	With signal cable interface adapter and no explosion protection (*1)
	E	For pressure clamp terminal block or MIL cable with explosion protection
	F	With signal cable interface adapter and explosion protection (*1)
	3	With ISA Standard G3 and temperature (-20 to 70 °C)
	C	With ISA Standard G3 and high-density installation (-20 to 70 °C)
<b>Option Codes</b>	/B4S00	With pressure clamp terminal block for digital input (without surge absorber) [Model: STB4S-00]
	/B4S10	With pressure clamp terminal block for digital input (with surge absorber) [Model: STB4S-10]
	/B4D00	With dual-redundant pressure clamp terminal block for digital input (without surge absorber) (*2) [Model: STB4D-00]
	/B4D10	With dual-redundant pressure clamp terminal block for digital input (with surge absorber) (*2) [Model: STB4D-10]
	/PRP	With prevention pin of false insertion (*3)
	/CCC01	With connector cover for MIL cable (for flat ribbon cable) [Model: SCCC01]
	/CCC02	With connector cover for MIL cable (for discrete wire) [Model: SCCC02]

\*1: When SDV144-S6□ or -SF□ is selected, you cannot choose the option code for a pressure clamp terminal block and MIL cable connector.

\*2: When this module is used in dual-redundant configuration, order an additional module with the same specification but without option codes.

\*3: When SDV144-S6□ or -SF□ is selected, you can choose the option code for prevention pin of false insertion. A mechanism to prevent wrong type I/O module insertion is supported with signal cable. The signal cable used with this I/O module must have option code /SDV144.

**Digital Output Module**

		Description
<b>Model</b>	SDV531	Digital output module (8-channel, 24 V DC, module isolation)
<b>Suffix Codes</b>	-L	Long distance type
	-S	Standard type
	5	For pressure clamp terminal block or MIL cable with no explosion protection
	6	With signal cable interface adapter and no explosion protection (*1)
	E	For pressure clamp terminal block or MIL cable with explosion protection
	F	With signal cable interface adapter and explosion protection (*1)
	3	With ISA Standard G3 and temperature (-20 to 70 °C)
	C	With ISA Standard G3 and high-density installation (-20 to 70 °C) (*4)
<b>Option Codes</b>	/B4S00	With pressure clamp terminal block for digital output (without surge absorber) [Model: STB4S-00]
	/B4S10	With pressure clamp terminal block for digital output (with surge absorber) [Model: STB4S-10]
	/B4D00	With dual-redundant pressure clamp terminal block for digital output (without surge absorber) (*2) [Model: STB4D-00]
	/B4D10	With dual-redundant pressure clamp terminal block for digital output (with surge absorber) (*2) [Model: STB4D-10]
	/PRP	With prevention pin of false insertion (*3)
	/CCC01	With connector cover for MIL cable (for flat ribbon cable) [Model: SCCC01]
	/CCC02	With connector cover for MIL cable (for discrete wire) [Model: SCCC02]

- \*1: When SDV531-□6□ or -□F□ is selected, you cannot choose the option code for a pressure clamp terminal block and MIL cable connector.
- \*2: When this module is used in dual-redundant configuration, order an additional module with the same specification but without option codes.
- \*3: When SDV531-□6□ or -□F□ is selected, you can choose the option code for prevention pin of false insertion. A mechanism to prevent wrong type I/O module insertion is supported with signal cable. The signal cable used with this I/O module must have option code /SDV531, /SDV53L or /DV53L.
- \*4: Suffix Code for "With ISA Standard G3 and high-density installation" is available in case of SDV531-L□C. This is not available in case of SDV531-S.

		Description
<b>Model</b>	SDV541	Digital Output Module (16-channel, 24 V DC, module isolation)
<b>Suffix Codes</b>	-S	Standard type
	5	For pressure clamp terminal block or MIL cable with no explosion protection
	6	With signal cable interface adapter and no explosion protection (*1)
	E	For pressure clamp terminal block or MIL cable with explosion protection
	F	With signal cable interface adapter and explosion protection (*1)
	3	With ISA Standard G3 and temperature (-20 to 70 °C)
	C	With ISA Standard G3 and high-density installation (-20 to 70 °C)
<b>Option Codes</b>	/B4S00	With pressure clamp terminal block for digital output (without surge absorber) [Model: STB4S-00]
	/B4S10	With pressure clamp terminal block for digital output (with surge absorber) [Model: STB4S-10]
	/B4D00	With dual-redundant pressure clamp terminal block for digital output (without surge absorber) (*2) [Model: STB4D-00]
	/B4D10	With dual-redundant pressure clamp terminal block for digital output (with surge absorber) (*2) [Model: STB4D-10]
	/PRP	With prevention pin of false insertion (*3)
	/CCC01	With connector cover for MIL cable (for flat ribbon cable) [Model: SCCC01]
	/CCC02	With connector cover for MIL cable (for discrete wire cable) [Model: SCCC02]

- \*1: When SDV541-S6□ or -SF□ is selected, you cannot choose the option code for a pressure clamp terminal block and MIL cable connector.
- \*2: When this module is used in dual-redundant configuration, order an additional module with the same specification but without option codes.
- \*3: When SDV541-S6□ or -SF□ is selected, you can choose the option code for prevention pin of false insertion. A mechanism to prevent wrong type I/O module insertion is supported with signal cable. The signal cable used with this I/O module must have option code /SDV541 or /DV541.

		Description
<b>Model</b>	SDV521	Digital Output Module (4-channel, 24 V DC/2 A, module isolation)
<b>Suffix Codes</b>	-S	Standard type
	6	With signal cable interface adapter and no explosion protection
	F	With signal cable interface adapter and explosion protection
	3	With ISA Standard G3 and temperature (-20 to 70 °C)
	C	With ISA Standard G3 and high-density installation (-20 to 70 °C)
<b>Option Codes</b>	/PRP	With prevention pin of false insertion (*1)

- \*1: The signal cable used with this I/O module must have option code /SDV521.

		Description
<b>Model</b>	SDV526	Digital Output Module (4-channel, module isolation)
<b>Suffix Codes</b>	-S	Standard type (*1)
	3	With signal cable interface adapter
	3	With ISA Standard G3 and temperature (-20 to 70 °C)

- \*1: with prevention of false insertion

		Description
<b>Model</b>	SDV53A	Digital Output Module (8-channel, 48 V DC, module isolation)
<b>Suffix Codes</b>	-S	Standard type
	6	With signal cable interface adapter and no explosion protection
	F	With signal cable interface adapter and explosion protection
	3	With ISA Standard G3 and temperature (-20 to 70 °C)
<b>Option Codes</b>	/PRP	With prevention pin of false insertion (*1)

\*1: The signal cable used with this I/O module must have option code /SDV53A or /DV53A.

**Wiring Diagnosis Elements**

		Description
<b>Model</b>	SCB100	Wiring Check Adapter for Digital Input (for defective open circuit detection while accepting off signals with ISA Standard G3) (*1)
<b>Suffix Codes</b>	-S	Standard type
	0	Always 0

\*1: Eight wires/set

		Description
<b>Model</b>	SCB110	Wiring Check Adapter for Digital Input (for defective short-circuited detection while accepting on signals with ISA Standard G3) (*1)
<b>Suffix Codes</b>	-S	Standard type
	0	Always 0

\*1: Eight wires/set

**■ STANDARD ACCESSORIES**

The fuse for SDV144 style code S1, S2 and S3 are replaceable.  
SDV144 style code S4 contains the fuse but it is not replaceable.

Accessory	Part number	Quantity	Remark
Fuse	A1327EF	1	Mounted

**■ APPLICABLE STANDARDS**

Refer to “ProSafe-RS Safety Instrumented System Overview (GS 32Q01B10-31E, GS 32Q01B20-31E)”.

**■ ORDERING INFORMATION**

Specify the model and suffix codes when ordering.

For selecting the right products for explosion protection, please refer to TI 32S01J30-01E without fail.

**■ TRADEMARKS**

- ProSafe is a registered trademark of Yokogawa Electric Corporation.
- Other company and product names appearing in this document are trademarks or registered trademarks of their respective holders.